



TIMTOS APP



Wechat

The official show daily of TIMTOS 2019

Total Visitor Count: 5,908 International: 2,523 Local: 3,385



## Contents

What's On at TaiNEX 2 ..... P3  
 Show Updates ..... P5  
 Industry Updates ..... P7  
 Exhibitor Interview ..... P9-11  
 Special Report ..... P12  
 Exhibit Highlights ..... P16-19

展覽新聞 ..... P24-25  
 南港2館專欄 ..... P27  
 工業資訊 ..... P29  
 專題報導 ..... P30-31  
 參展商採訪 ..... P32-34  
 產品報導 ..... P36-38

# Top Class Exhibition Featuring Machine Tools of the Future

The 27th edition of the globally established Taipei Int'l Machine Tool Show (TIMTOS) now opens its doors making it a momentous celebration, as it launches Taiwan's first Gold-Standard Green Exhibition Hall and TaiNEX 2, the biggest exhibition venue in the country, including a new chapter for Taiwan's MICE industry.

Co-hosted by TAITRA and TAMI, the 2019 TIMTOS runs from March 4-9, at Taipei

Nangang Exhibition Center Hall 1&2, and TWTC Hall 1&3. The six-day show gathers 1,230 exhibitors, bringing to life 7,000 booths, the greatest number of booths ever used in Taiwan, and welcoming 7,500 international buyers and 52,700 Taiwanese industry visitors.

TIMTOS this year features exhibitors from 26 countries, which includes industry giants: DMG MORI, MAZAK, FANUC,

SIEMENS, SODICK, and HEIDENHAIN. Local exhibitors include Fair Friend Group, Chain Headway, Soco Machinery, Tongtai, Kao Fong Machinery, Po Ly GIM, Goodway, Shinwu, Chevalier, PMI-Group, and Deta. In addition to a number of exhibitors from Switzerland and Germany, companies from USA, Denmark and Turkey are featured in the national pavilions for the first time. This leads to the fact that TIMTOS has become a major

show for global manufacturers to demonstrate their advanced machines and technologies.

Mr. James C. F. Huang, Chairman, Taiwan External Trade Development Council (TAITRA), said, "This year's trade fair is extra special with the brand new hall in which the facilities provide TIMTOS as one of the world's top-3 machine tool show, held right here in Taiwan, a small nation no bigger than the size of Switzerland."

>> Go to P1

攤位號 J0330

## 全球第三大工具機集團 World 3<sup>rd</sup> Largest Machine Tools Group

全球 37 大品牌 · 50 個生產基地  
37 Brands and 50 Production Bases Worldwide



**Taiwan External Trade Development Council**  
tintos@taitra.org.tw  
www.taiwantrade.com.tw  
www.taitra.org.tw



**TAIWAN ASSOCIATION OF MACHINERY INDUSTRY**  
tintos@tami.org.tw  
www.tami.org.tw

**Ringier Trade Media Ltd.**

Booth : Nangang 1 Hall I2138  
Free sourcing service  
www.industysourcing.cn



**FX-800**

## Smart, Exquisite And Exceptional Mechanical



**LA-250YS**



**MX-800**

Taiwan TAKISAWA Technology Co., Ltd.

+886-3-4643166

info@takisawa.com.tw

www.takisawa.com.tw







**Dr. Ing-Wen Tsai**  
President  
Republic of China (Taiwan)



**Mr. James C. F. Huang,**  
Chairman  
TAITRA



**Mr. Alex Ko**  
Chairman  
TAMI



**Mr. David DuBois**  
CEO, International  
Association of Exhibitions  
and Events (IAEE)

#### >> From C1

It is THE must-attend event for all decision makers in the machine tools industry. This year's exhibition guides you to the largest in TIMTOS' history and the third largest of its kind in the world. It is expected to once again be the industry platform for exchange of information and expertise following the theme of Smart Manufacturing."

From March 4 to 9, 2019, visitors can inform themselves of the new AR Experience Zone, which uses Augmented Reality (AR) to demonstrate the structures of metal-forming machines. Taiwanese machine tool companies apply robotic arms, automatic die change systems, sensors, and AI applications and together with production management systems and remote management, to build smart production lines of metal-cutting and aluminium alloy casting. For example, YCM's Smart Factory, Kao Fong's new 5-Axis Machine and Double-column Machine, and Honor Seiki's new generation machine tools specifically designed for making aircrafts.

### Comprehensive exhibition and forum program

TAITRA presents a thrilling exhibition program, an extensive summit and networking opportunities with the Who's Who of the entire machine tool ecosystem. Since the beginning, TIMTOS helps you set your focus and give guidance for your business and strategy.

The TIMTOS Summit at TICC assembles top executives from international and local firms including ABB, Optomec, Dassault Systèmes, Airbus, DMG, Siemens and Bosch Rexroth. These companies will focus on Machine Intelligence and AIoT, Additive Manufacturing, Innovation in Aerospace Manufacturing, Automotive Manufacturing Revolution to explore advanced application techniques and industrial trends.

In parallel, the show features multiple

events including the 14th Ceremony of Taiwan Machine Tool Industry Awards for Excellence in Research & Innovation, TIMTOS 2019 One-on-One Procurement Meetings, Market Briefing of Machinery Industry in Malaysia & Signing Ceremony for the Memorandum of Understanding between TAITRA and PENFEIA (Penang Foundry & Engineering Industries Association), Taiwan-Japan Machinery Enterprise Economic and Trade Exchange Meeting, and the 'Germany Company Talk @ TIMTOS. There will also be 40 seminars on new technologies and new product launches.

Industry 4.0, Smart Manufacturing, and AI are the focus of this year's show. From R&D to integrated supply chains, from specialized units to total solutions, TIMTOS can help you find the tools and services you need to optimize your operation.

Machines are the foundation of all industries, according to Mr. Huang, "Today, we would like to show you how Taiwan can help you turn your ideas into action, transform your vision into reality, and build the future you've always dreamed about," he stated.

Mr. Huang pays tribute to all the makers and builders of all the tools and the machinery during his speech. "All the cogs and the wheels that keep our world turning. To all our exhibitors, partners and friends, we salute you. You shape our world," he acknowledges.

Mr. Alex Ko, Chairman, Taiwan Association of Machinery Industry (TAMI), remarked, "TIMTOS serves more than as a stage for global manufacturers to show their products, it is also a place for recruiting the best talents. This year students take great initiative to learn from the show, with more than 5,200 students coming from 130 classes of 50 schools, more than that of the previous year."

Mr. Ko expressed its appreciation of the Ministry of Education and

related sectors, through which they are able to run the event smoothly, while realizing the practical learning of post-secondary and higher education. He also added the participation of ITRI and PMC (Precision Machinery Research Development Center) in the show, together with new faces including Chung Cheng University, Formosa University, and the Global Research & Industry Alliance of the Department of Engineering and Technology of Ministry of Science and Technology; and expects even more professionals to join the show in the future.

During the opening ceremony, TAITRA and TAMI thanked the long term support and assistance of President Tsai, President Su of the Legislative Yuan, and Deputy Minister Tseng of the Ministry of Economic Affairs. With hopes that the government will protect the export of Taiwan machines, and the Central Bank to activate the defensive depreciation mechanism to avoid the impact that Taiwan dollar exchange rate has on machine export, as a response to the ever changing global economy.

### Smart machines and manufacturing

In August, TAMI published an industry white paper about smart machinery with plan to continue on the direction of smart machine and smart manufacturing, and become the world's capital for producing smart machines.

TAMI revealed that it will facilitate and support smart machines to connect to the cloud and build a team to help construct a cloud service platform specifically for machines and to demonstrate and promote this platform to the equipment manufacturers. This will add values to the machinery industry and help the industry to reach NT\$2 trillion production values by 2025.

Taiwan Machinery industry continues to grow with an industry production value exceeding NT\$1.1 trillion. The export value of machinery industry reached US\$27.4 billion in 2018, a 7.2% increase from 2017, while the production value increased by NT\$80 billion and reached NT\$1.18 trillion, representing a 7.3% growth and creating new history records. The export value of machinery tools were US\$3.66 billion, increased by 9.5% compared to last year.

Taiwan is a nation of smart manufacturing. TIMTOS' mission is to connect with all attendees, to grow with them, and to thrive with them. The country is not big in size, but we're big in mind. TIMTOS is the perfect example: a celebration of engineering and human ingenuity on a small island nation taking on big global challenges.

In closing, Mr. Huang emphasized, "Taiwan is not big in size, but we fostered many industries that can rival the world's best of the best. Taiwan's machine tool industry has long been competing head-to-head with the world's top machine tool makers who're also global industrial giants. How's this possible, you may ask, when Taiwan possesses nowhere as much natural resources as Germany, Italy or Japan? It's true, our resources are limited, but we can still be resourceful. The fact that we are all gathered here in this new hall for TIMTOS 2019 speaks volumes about human ingenuity in the face of challenge."

The show opens daily from 10:00 to 18:00. Free admission with business cards is available for professional visitors. Tickets can be purchased for the general public at NT\$200 per ticket. Booths are open till 16:00. Local students from industry-relevant fields are required to present a student ID for free admission. The show will not admit children under 12 years old. ■

# TIMTOS 2019 EVENT / SEMINAR PROGRAM

Date	Time	Event/Seminar	Organizer	Venue	Remarks
3/4 (Mon.)	10:30	Opening Ceremony	TAITRA, TAMI	Lobby, 4F, Taipei Nangang Exhibition Center, Hall 2	By Invitation Only, Miranda Chien +886-2-27255200#2867
	8:00-17:00	Bfuture Global Launch & Products Announcement	Ching Hung Machinery & Electric Industrial Co., Ltd.	Room 402c, Taipei Nangang Exhibition Center, Hall 1	+886-4-23509188#527
	8:00-17:00	Fagor CNC & Feedback Systems Products Introduction	Fagor Automation Taiwan Co., Ltd.	Room 602, Taipei Nangang Exhibition Center, Hall 2	Samuel Wen +886-4-23851558
	13:30-16:30	TIMTOS 2019 Procurement Meetings	TAITRA	Room 504, Taipei Nangang Exhibition Center, Hall 1	Tina Ko +886-2-27255200#1573
	14:00-15:00	Press Conference, TIMTOS 2019	TAITRA TAMI	Room 403, Taipei Nangang Exhibition Center, Hall 1	Savannah Hou +886-2-23494677
	16:00-17:30	Market Briefing of Machinery Industry in Malaysia & Signing Ceremony for the Memorandum of Understanding between Penang Foundry & Engineering Industries Association (PENFEIA) and Taiwan External Trade Development Council (TAITRA)	TAITRA	Room 404, Taipei Nangang Exhibition Center, Hall 1	Melody Chen +886-2-27255200#2693
3/5 (Tue.)	8:00-17:00	Bfuture Global Launch & Products Announcement	Ching Hung Machinery & Electric Industrial Co., Ltd.	Room 402c, Taipei Nangang Exhibition Center, Hall 1	+886-4-23509188#527
	8:00-17:00	Fagor CNC & Feedback Systems Products Introduction	Fagor Automation Taiwan Co., Ltd.	Room 602, Taipei Nangang Exhibition Center, Hall 2	Samuel Wen +886-4-23851558
	8:30-12:00	Intelligent Manufacturing and Machine Tool Key Component Application Technology	Intelligent Machinery Technology Center, ITRI	Room 505a, Taipei Nangang, Exhibition Center, Hall 1	Helena Chang +886-49-2345309
	9:00-12:00	台日機械企業經貿交流會	TAMI	Room 504bc, Taipei Nangang Exhibition Center, Hall 1	+886-2-23494668
	9:00-16:00	TIMTOS 2019 SUMMIT	BOFT, MOEA	Room 101, TICC	Lilyan Kao +886-2-27255200#2679
	16:00-17:00	German Company Talk @ TIMTOS	TAITRA German Trade Office Taipei	Room 101, TICC	Suzie Cheng +886-2-7735-7524
	10:00-12:00	Renishaw's XK10 alignment laser system-new tool for machine tool assembly and alignment	Renishaw (Taiwan) Inc.	Room 402a, Taipei Nangang Exhibition Center, Hall 1	Eric Chuang +886-4-24603799
	10:30-12:00	TNC 640 高效率五軸輪廓控制器 - 高可靠度創新加工技術的優勢	HEIDENHAIN Co., Ltd. (Taiwan)	Room 403, Taipei Nangang Exhibition Center, Hall 1	Gloria Tsai +886-4-2358-8977 #1035
	13:00-15:00	NIDEC- Commander C Product Launch	Raise Precision Co., Ltd.	Conference Room 4, TWTC Exhibition Hall 1	Judy Chen +886-4-22606502
	13:00-15:00	Industry 4.0- Intelligent Manufacturing Conference/Mold intelligent production unit	Accutex Technologies Co., Ltd.	Room 402ab, Taipei Nangang Exhibition Center, Hall 1	+886-4-23599688#226
	14:00-15:00	JIMTOF 2020 Press Conference	Japan Machine Tool Builders' Association	Room 404, Taipei Nangang Exhibition Center, Hall 1	Keiko Honda +81-3-34343961
	14:30-16:30	智慧製造聯網數據加值產業聯盟會員大會	ITRI	Room 504a, Taipei Nangang Exhibition Center, Hall 1	+886-3-5916720
	15:00-16:00	臺灣機械工業同業公會與馬來西亞檳城機器廠商會簽訂合作協議	TAMI	VIP Briefing Room, 4F, Taipei Nangang Exhibition Center, Hall 1	Ryan Lin +886-2-23494694
	15:00-17:30	Litz Hitech Global Dealer Meeting and New Product Announcement	Litz Hitech Corporation	Room 401, Taipei Nangang Exhibition Center, Hall 1	Lisa Mo +886-4-26815711#246
18:30	Reception for TIMTOS 2019 and the Ceremony of Taiwan Machine Tool Industry Awards for Excellence in Research & Innovation	TMTF, TAITRA, TAMI	The Banquet Hall, 3F, Taipei Nangang Exhibition Center, Hall 1	Bonnie Tsai +886-2-23110358	
3/6 (Wed.)	8:00-17:00	Bfuture Global Launch & Products Announcement	Ching Hung Machinery & Electric Industrial Co., Ltd.	Room 402c, Taipei Nangang Exhibition Center, Hall 1	+886-4-23509188#527
	8:00-17:00	TIMTOS 2019 High School, University Students Guided Tour	TAMI	Room 500, Taipei Nangang Exhibition Center, Hall 1	+886-2-23494672
	8:00-17:00	Fagor CNC & Feedback Systems Products Introduction	Fagor Automation Taiwan Co., Ltd.	Room 602, Taipei Nangang Exhibition Center, Hall 2	Samuel Wen +886-4-23851558
	9:00-16:00	TIMTOS 2019 SUMMIT	BOFT, MOEA	Room 101, TICC	Lilyan Kao +886-2-27255200#2679
	16:00-17:00	German Company Talk @ TIMTOS	TAITRA German Trade Office Taipei	Room 101, TICC	Suzie Cheng +886-2-7735-7524
	8:00-17:00	The Trend of Industry 4.0 and Intelligent Machinery Technical Application Seminar	igus Taiwan Company Ltd. CTIMES	Room 505, Taipei Nangang Exhibition Center, Hall 1	KF Sun +886-2-25855526#225
	9:00-11:00	YCM Dealer Meeting	Yeong Chin Machinery Industries Co., Ltd.	Room 401, Taipei Nangang Exhibition Center, Hall 1	Claire Chen +886-4-25623211#1812
	10:30-12:00	選擇美國投資研討會 - 錢進美國教戰守則	AIT TAMI	Room 501, Taipei Nangang Exhibition Center, Hall 1	Jackie Hong +886-2-27201550#334
	13:00-17:00	New Product Launch	Vision Wide Tech Co., Ltd.	Room 502, Taipei Nangang Exhibition Center, Hall 1	Michelle Huang +886-4-22712000#231
	13:00-17:00	Goodway Group New Product Launch Event	Goodway Group	Room 504a, Taipei Nangang Exhibition Center, Hall 1	Lisa Chiang +886-4-24629698#62107
13:30-16:30	Application of mineral casting (polymer composite) in machinery field	Shandong Nano Advanced Materials Technology Co., Ltd.	Room 304, Taipei Nangang Exhibition Center, Hall 1	+86-531-88917773	
13:30-17:00	中國砂輪新產品發表會	KINIK COMPANY	Conference Room 2, TWTC Exhibition Hall 1	+886-2-26791931#3309	
3/7 (Thu.)	8:00-17:00	直得科技新品說明會	Chieftek Precision Co., Ltd.	Room Happiness, 3F, Taipei Nangang Exhibition Center, Hall 1	+886-6-5055858#162
	8:00-17:00	Bfuture Global Launch & Products Announcement	Ching Hung Machinery & Electric Industrial Co., Ltd.	Room 402c, Taipei Nangang Exhibition Center, Hall 1	+886-4-23509188#527
	8:00-17:00	TIMTOS 2019 High School, University Students Guided Tour	TAMI	Room 500, Taipei Nangang Exhibition Center, Hall 1	+886-2-23494672
	8:00-17:00	Fagor CNC & Feedback Systems Products Introduction	Fagor Automation Taiwan Co., Ltd.	Room 602, Taipei Nangang Exhibition Center, Hall 2	Samuel Wen +886-4-23851558
	13:30-17:00	2019 台北國際工具機展 GLORIA 智慧製造創新應用論壇	MOST, TAITRA, TAMI	Room 402ab, Taipei Nangang Exhibition Center, Hall 1	Jessica Guo +886-2-25774249#827
	14:00-16:00	Energy Saving Technology for Hydraulic System and Filtration of Cooling Lubricant	HYDAC Technology Ltd. Sterling TSI Co., Ltd.	Room 502, Taipei Nangang Exhibition Center, Hall 1	Jojo Yang 886-4-22602278
14:00-16:00	Improving the quality and efficiency of grinding processing	Join Star Trading Co., Ltd.	Room 505b, Taipei Nangang Exhibition Center, Hall 1	Jamie Chang +886-2-29115226#607	

Subject to change without notice.



## The Features of TaiNEX 2



**T**aipei Nangang Exhibition Center, Hall 2 (TaiNEX 2), an expansion project invested by the Ministry of Economic Affairs (MOEA) and operated by Taiwan External Trade Development Council (TAITRA), opened on March 4th, 2019. TaiNEX 2 has unique sky garden on the top floor and will attract more international exhibitions, conferences, and business meetings to be held in Taiwan.

TaiNEX 2 is designed by famous architectural design companies - gmp Architects von Gerkan, Marg and Partners

from Germany and J.J Pan and Partners from Taiwan. Its design follows ancient Roman architecture's three principles – utility, solidity, and beauty. The appearance of TaiNEX 2 is neat and penetrating.

Combined with the spaces of Taipei Nangang Exhibition Center, Hall 1 (TaiNEX 1) and TaiNEX 2, the total capacity reaches to 5,000 booths and 38 meetings rooms to meet international MICE activities' needs. TaiNEX 1 and TaiNEX 2 will become the core venue of Taiwan MICE industry and one of the major exhibition and convention centers in Asia.

TNEC2 features are:

1. The first exhibition hall to be awarded the "Green Building Label - Golden Level" in Taiwan.

2. TaiNEX 2's roof is designed to symbolize ocean waves, in keeping with the nautical theme of TaiNEX 1's rooftop which resembles a ship's mast. TaiNEX has become MICE new landmark in Taiwan.

3. Convenient transportation: 45

minutes from Taoyuan International Airport by car, 15 minutes from city center by metro, and only one stop away from Nangang station, where Taipei Metro system, Taiwan Railway and Taiwan High Speed Rail station are all connected at. Besides that, pedestrian underpass connects Taipei Metro system and TaiNEX 2.

4. 15 minutes from Taipei city center to TaiNEX 2 by Metro and can reach 500 hotels with 25,000 rooms available in Taipei easily.

5. High ceiling exhibition halls: 12 meters on the 1st floor and 9 meters on the 4th floor, adding space for 2,360 new booths.

6. The multifunctional conference hall on the 7th floor is the biggest non-pillar conference space in Taiwan, which has 9-meter ceiling height, 14 convertible meeting rooms and maximum capacity of 3,600 persons.

7. The glass curtain wall and wide corridors in the 7th floor allow visitors to see the outside view of the 6,100sqm Sky Garden and Taipei 101.

8. Sufficient parking area with 1,296 indoor parking spaces served with a smart parking system and 4-meter ceiling height to let shuttle buses and trucks go directly into the basement.

9. The 28 escalators can be used by attendees and the 16 lifts for deliveries to promote smooth and fast flow of traffic.

After TIMTOS 2019, there are more big international exhibitions are held at TaiNEX such as AMPA, Computex, Food Taipei, and Taipei Cycle Show. International conferences including Rotary International Convention in 2021 will choose TaiNEX too. In the future, we look forward more global MICE activities being held at TaiNEX in Taiwan! ■

**TaiNEX 2 Press information contact window :**

**Macy Chen**  
Senior Project Manager  
Nangang International Exhibition Center, Hall 2  
02-2725-5200 #6616  
macy@taitra.org.tw

## MicroLab: Moving Forward to World-Class High-Performance Spindle

**K**nown for its expertise in various high-order spindles, MicroLab makes a stunning debut in TIMTOS 2019 at Nangang Hall 2.

Spindle as the core key component of machine tools, the advanced spindle has long been monopolized by foreign technology.

In order to achieve the local production of the spindle, MicroLab designed Pulley Driven Spindle, Direct-Drive Spindle, Tapping Center Spindle. Built-in Motor spindle has long been as the core of R&D direction, MicroLab launched the special functional integrated Rotary Spindle Head, Capto Turning/Milling Spindle and Hydrostatic Spindle and Rapid Cutting Spindle with high torque and power.

For the Built-in Motor Spindle, adopts strict Labyrinth design with air seal. During high-speed operation, positive air pressure

coming out from the labyrinth prevents any contamination from entering into the spindle. Whole series equipped with Water-repellant Ring to effectively repel any cutting fluids away from the spindle to prevent anything from splashing into the labyrinth area during high-speed cutting.

Highly efficient helical Cooling Channel can effectively dissipate heat from the stator coil and bearings to reduce the effects of thermal deformation on precision. The patented Anti-Rotating Gripper Guide Ring eliminates any unusual noises and vibration of dynamic balance. Single External Housing Body Piece, ensures the accuracy of installed contacts, greatly increase the machine precision and shrunk the calibration time. And Multi-times and Multi-planes Balance Calibration, including Damping Mechanism, effectively upgrade

the vibration capacity.

The Rotary Spindle Head, such as ISO25, BT30, BT40, HSK40E, HSK63A and other products are suitable for 5-axis machining machines with B-axis design, which are mainly used in 3C electronics industry and aerospace or wide variety applications processing. Another large built-in motor spindle HSK100A is suitable for high speed and high rigidity machining of large gantry machines.

To follow the current trend of intelligent manufacturing and Industry 4.0, MicroLab keeps learning and updating. At present, MicroLab implants sensors in every spindle product, so that the user can monitor the spindle at any time. Customer's feedback drives innovation and encourages us to become more aware of the market trends. ■



**MicroLab Precision Technology Co., Ltd.**  
Tel: +886-4-2239-2345  
Fax: +886-4-2239-2357  
Email: microlab@twspindle.com  
Website: www.twspindle.com.tw  
Booth No.: Q1212

## TIMTOS 2019 EVENT / SEMINAR PROGRAM

3/8 (Fri.)	8:00-17:00	直得科技新品說明會	Chieftek Precision Co., Ltd.	Room Happiness, 3F, Taipei Nangang Exhibition Center, Hall 1	+886-6-5055858#162
	8:00-17:00	Bfuture Global Launch & Products Announcement	Ching Hung Machinery & Electric Industrial Co., Ltd.	Room 402c, Taipei Nangang Exhibition Center, Hall 1	+886-4-23509188#527
	8:00-17:00	TIMTOS 2019 High School, University Students Guided Tour	TAMI	Room 500, Taipei Nangang Exhibition Center, Hall 1	+886-2-23494672
	8:00	Fagor CNC & Feedback Systems Products Introduction	Fagor Automation Taiwan Co., Ltd.	Room 602, Taipei Nangang Exhibition Center, Hall 2	Samuel Wen +886-4-23851558
	9:30-18:00	智慧製造論壇	Fusionmedium TAITRA	Conference Room 4,5, TWTC Exhibition Hall 1	Sica Lin +886-2-87715865#180
	9:30-14:00	Diplomatic Motion Solution Product Training and Conference	Diplomatic MS S.p.A Ace Pillar Co., Ltd.	Room 502, Taipei Nangang Exhibition Center, Hall 1	+886-2-29958400#1232
	10:00-17:00	中興大學與精密機械研究發展中心智慧機械產學論壇技術成果發表會	國立中興大學 & 財團法人精密機械研究發展中心	Taipei Nangang Exhibition Center, Hall 1	+886-4-22858139
3/9 (Sat.)	13:00-16:00	3D Printing+3D Scanning	Road Ahead Technologies Consultant Corp	Room 404, Taipei Nangang Exhibition Center, Hall 1	Evelyn Lin +886-2-2999-6788#284
	8:00-17:00	TIMTOS 2019 High School, University Students Guided Tour	TAMI	Room 500, Taipei Nangang Exhibition Center, Hall 1	+886-2-23494672
	8:00-17:00	Fagor CNC & Feedback Systems Products Introduction	Fagor Automation Taiwan Co., Ltd.	Room 602, Taipei Nangang Exhibition Center, Hall 2	Samuel Wen +886-4-23851558

Subject to change without notice.



新世代智能化控制 / 全方位的加工對策

# 攜手邁向智慧製造

## SMART MANUFACTURING STARTS HERE!

**AiLINC** COMING SOON

**i Console**

**G.LINC**  
**G.NET**



### GRW series

走頭式外圓磨床

Traveling Head Cylindrical Grinder



### RG5 series

天車式高速五軸加工機

High Speed Gantry Type 5-axis Machining Center



### GVF series

高剛性立式車銑複合機

Super Rigid Vertical Turning Center

**TIMTOS**

2019 台北國際工具機展

南港 1 館  
攤位號碼：

# I 0816

**AWEA** 亞崙機電



亞崙機電股份有限公司  
AWEA MECHANTRONIC CO., LTD.  
+886-4-2462-9698 sales@awea.com  
www.AWEA.com

**GOODWAY** 程泰機械



程泰機械股份有限公司  
GOODWAY MACHINE CORP.  
+886-4-2463-6000 goodway@goodwaycnc.com  
www.GOODWAYCNC.com

**EXTRON** 益全機械



益全機械工業股份有限公司  
YIH CHUAN MACHINERY INDUSTRY CO., LTD.  
+886-4-2359-3351 sales@extroncnc.com  
www.EXTRONCNC.com



## TIMTOS Press Conference Emphasizes Industry 4.0 and Smart Factory

The Press Conference of TIMTOS 2019 was held at Meeting Room 403, Nangang Exhibition Center, Hall 1. There has been a lot of information about the trend of manufacturing development and market potential shared by the speakers.

Mr. Thomas HUANG, Executive Director of Exhibition Department, Taiwan External Trade Development Council (TAITRA), pointed out several highlights about TIMTOS 2019. TIMTOS 2019 has in total invited 1,230 exhibitors from both domestic and international regions with up to 7,000 booths used. It is now not only the largest TIMTOS ever, but also the world's third largest machine tools exhibition. In addition to the key industry members from Taiwan, many international brands can also be seen at the show, including MAZAK, DMG MORI, FANUC, Mitsubishi, Heidenhain, Siemens, Haas Automation, and Universal Robots. The TIMTOS 2019 theme is "Industry 4.0 & Smart Manufacturing". There are abundant exhibits for new system integration and digitalized manufacturing solutions. These include robots, sensors, IoT technology, cloud platforms, and Big Data analysis, all of which can assist manufacturers to build a more flexible, efficient, and smarter production line, and enable Industry 4.0 production for small quantities and diverse requirements. Many domestic and international exhibitors are showcasing their new AI technology and the collaborative robots. By incorporating artificial intelligence into manufacturing systems, "human-machine synergy" manufacturing can be created. This new

collaboration can further decrease human error while enhancing work precision and product quality, resulting in safer and more efficient production lines. In response to the current industry trends and smart manufacturing theme, the second edition of TIMTOS Summit will take place on March 5th and 6th at The Taipei International Convention Center, Room 101. As an international procurement platform with a mission to help exhibitors to explore worldwide markets, TAITRA and its branch offices worldwide have co-jointly organized intensive promotion campaigns.

Mr. Ingo CHEN, Chairman of Machine Tool Committee, Taiwan Association of Machinery Industry (TAMI), gave an overview of Taiwan's machine tools. In recent years, Taiwan's machine tools have been particularly successful in developing new models and expanding overseas markets. In 2018, with the efforts of all parties, the annual export value achieved a remarkable performance of US\$3.66 billion, a 9.5% increase over the same period last year. Faced with the slowdown in China-US trade and international market demand, Taiwan's machine tool industry is cautious towards the prospects for 2019. It is the best time for companies to adjust their pace and reorganize their market strategies. For example, the companies should explore production bases in Vietnam, Indonesia and other Southern Asian countries. Today, in response to the global trend of smart machinery and manufacture, the government has included smart machinery in the "Five Plus Two" innovation industry plan.



( Left to Right ) C. C. WANG, President of TAMI; Habor HSU, Chairman of Machine Parts & Elements Committee of TAMI; Ingo CHEN, Chairman of Machine Tool Committee of TAMI; Thomas HUANG, Executive Director of Exhibition Department of TAITRA; Wen Lung HSIAO, Chairman of Metal Forming Machinery Committee of TAMI

Taiwan's machinery industry has a complete supply chain model, and it has abundant research and development energy to meet the needs of aerospace, automotive, medical, consumer electronics, and energy industries, as well as precision molds and parts processing equipment. In the future, the industry will continue to innovate and plant the seeds for the growth of key technologies, to strengthen international competitiveness, and to win success for Taiwan.

What's more, Mr. Habor HSU, Chairman of Machine Parts & Elements Committee, Taiwan Association of Machinery Industry (TAMI) and Mr. Wen Lung, HSIAO Chairman of Metal Forming Machinery Committee, Taiwan Association of Machinery Industry (TAMI), both made the related presentations.

Mr. Habor HSU emphasized that many machine parts makers expanded their products and services to the high-end markets such as Europe, United States, and Japan. They must also be even more flexible in transforming their manufacturing, adopt new technologies, and create their own smart manufacturing solutions. Mr. Wen Lung HSIAO argued that China market still has great possibility for more growth due to its huge domestic demand. Among all the markets matching the government's New Southbound Policy, India, Vietnam, Turkey and the US are the markets with the most business potential for machinery sales driven by their transformation to more automated production. In addition, Virtual Reality (VR) was proved to be an excellent way to demonstrate metal forming equipment. ■

## TIMTOS Int'l Buyers Embracing Taiwanese Machines

The reason why international buyers would like to buy Taiwanese machine tools again and again and year after year, is the fact Taiwan machine tools are truly good in quality and competitive in price, according to buyers from different countries

during the procurement meeting following the opening of TIMTOS 2019 yesterday.

Taipei International Machine Tools Show was opened on March 4, 2019 at Taipei Nangang Exhibition Center, Hall 2, a procurement meeting was followed

immediately between international buyers and Taiwanese manufacturers. Twenty two international machine tools' big traders successfully negotiated with their potential partners about their innovative, efficient and most advanced machine tools Made In Taiwan (MIT).

Several buyers proudly revealed that they have been to TIMTOS for more than five to more times. They actually come to Taiwan to buy machine tools almost every year. They put Taiwan on their first priority in purchasing machine tools because they all like the good quality and price of Taiwanese products. They would like to buy almost all kinds of models, including lathes, grinding machines, drillings and systems made in Taiwan.

Since they are coming to buy machines almost every year, how come that they still have to watch TIMTOS with high expectation as well? "Simply because

Taiwanese machine tools are improving technically & functionally every year, and makers in Taiwan always show their most cutting-edge innovations in TIMTOS. So that I make watching TIMTOS a must see every two years other than yearly purchase," said Rohit Rai from New Delhi, India. For the last twenty five years, Rai has come to buy Taiwanese machines without missing a year.

Taipei International Machine Tools Show Procurement Meeting was arranged originally by foreign trade representatives of TAITRA stationed in the offices abroad. They would recommend and list some good quality businesses online first on platform of TAITRA, to help machine tools makers in Taiwan to apply for appointment with the buyers on the list. After the buyers around the world agree to meet, Taiwanese manufacturers could have the opportunity to see their potential buyers during the meeting. ■



# TIMTOS 2019 Summit

Time: 09:00-17:00, Tuesday, March 5, 2019  
Location: Room 101, TICC (No. 1, Sec. 5, Xinyi Road, Taipei)

Time: 09:00-17:00, Wednesday, March 6, 2019  
Location: Room 101, TICC (No. 1, Sec. 5, Xinyi Road, Taipei)

Session 1: Machine Intelligence and AIoT	
Time	Agenda / Speaker
09:00-09:20	Registration
09:20-09:30	Opening Remarks Leonor F. M. Lin, Executive Vice President of TAITRA Alex Ko, Chairman of TAMI
09:30-10:10	【Keynote】 How SAP helps Customers to Create Value with Industry 4.0 and Internet of Things in Discrete Industries Bernhard Meyer, SAP Global Solution Manager, Industry Business Unit, Industrial Machinery & Components (IM&C)
10:10-10:50	【Keynote】 The Intelligent IoT Asset Management Platform for Smart Factory Arthur Liu, Vice President, ITTS
10:50-11:30	【Keynote】 Realization of Taiwan Industrial Internet of Things Application from Industry-University Cooperation Wen-Yuh Jywe, President of National Formosa University
11:30-12:10	【Keynote】 Trends of Industrial AI and Industrial Internet Jay Lee, Professor at the University of Cincinnati
12:10-12:30	【Panel Discussion】 The Future of Work Moderator: K.C. Chuang, Honorary Chairman of TAMI Panelists: All Speakers

Session 2: Additive Manufacturing	
Time	Agenda / Speaker
13:00-13:30	Registration
13:30-14:10	【Keynote】 Advanced Machining Solutions for the Future of Manufacturing Dr. Neun Harald, COO, DMG MORI
14:10-14:50	【Keynote】 The Evolution of Metal Additive Manufacturing: Leveraging the Machine Tool Infrastructure Pascal Pierra, Director of Asia-Pacific, Optomec
14:50-15:20	【Keynote】 Making Production Real Oscar Yang, Sales Director of Great China, Road Ahead Technologies Consultant
15:20-16:00	【Panel Discussion】 Metal Additive Manufacturing - Now & Future Moderator: Catherine Lu, TV Journalist focused on Global Technology
16:00-17:00	【Side Event】 German Company Talk @ TIMTOS

Session 3: Innovation in Aerospace Manufacturing	
Time	Agenda / Speaker
09:00-09:30	Registration
09:20-10:00	【Keynote】 Master highly dynamic machining strategies with innovative solutions in the field of drive and control technology Peter Topol, Senior Product Manager, Heidenhain
10:00-10:40	【Keynote】 Embracing Industry 4.0 and Transform towards a Digital Future with Siemens Tino Hildebrand, Vice President, Siemens Ltd., Taiwan
10:40-11:20	【Keynote】 The role of the digital collaboration and innovation in the renaissance of the Aerospace Manufacturing Rémi GERMAIN, Aerospace & Defense Industry Sales Director, Dassault Systèmes
11:20-12:00	【Keynote】 Advanced manufacturing technologies Cyrille SCHWOB, Head of Technology, Asia-Pacific, Airbus
12:00-12:30	【Panel Discussion】 Transforming Manufacturing - what can we see in the next 5 years Moderator: Jwu-Sheng Hu, Vice President and General Director, Mechanical and Mechatronics Systems Research Laboratories, ITRI Panelists: All Speakers

Session 4: Automotive Manufacturing Revolution	
Time	Agenda / Speaker
13:00-13:30	Registration
13:30-14:10	【Keynote】 The Technology and Application of Industrial Robotics to New Era of Smart Manufacturing HT Choong, Regional Manager- Service Sales (SAS & Taiwan), ABB
14:10-14:50	【Keynote】 CNC Systems for Factory of the Future Charlie Chen, Division Manager of Industrial & Mobile Application, Bosch Rexroth Taiwan
14:50-15:20	【Keynote】 Intelligent Factory Automation (iFA) for Industry 4.1 Fan-Tien Cheng, Director, Intelligent Manufacturing Research Center, National Cheng Kung University
15:20-16:00	【Panel Discussion】 The Revolution is Speeding Up - Are We Ready? Moderator: Jwu-Sheng Hu, Vice President and General Director, Mechanical and Mechatronics Systems Research Laboratories, ITRI Panelists: All Speakers
16:00-17:00	【Side Event】 German Company Talk @ TIMTOS

\*Topics are subject to change and will be updated anytime.  
\*Chinese/English onsite simultaneous interpretation provided.

## Speakers / Moderators

<p><b>Bernhard Meyer</b> SAP Global Solution Manager, Industry Business Unit, Industrial Machinery &amp; Components (IM&amp;C)</p> 	<p><b>Dr. Neun Harald</b> COO, DMG MORI</p> 	<p><b>Peter Topol</b> Senior Product Manager, Heidenhain</p> 	<p><b>Jwu-Sheng Hu</b> Vice President and General Director, Mechanical and Mechatronics Systems Research Laboratories, ITRI</p> 
<p><b>Arthur Liu</b> Vice President, ITTS</p> 	<p><b>Pascal Pierra</b> Director of Asia-Pacific, Optomec</p> 	<p><b>Tino Hildebrand</b> Vice President, Siemens Ltd., Taiwan</p> 	<p><b>HT Choong</b> Regional Manager- Service Sales (SAS &amp; Taiwan), ABB</p> 
<p><b>Wen-Yuh Jywe</b> President, National Formosa University</p> 	<p><b>Oscar Yang</b> Sales Director of Great China, Road Ahead Technologies Consultant</p> 	<p><b>Rémi GERMAIN</b> Aerospace &amp; Defense Industry Sales Director, Dassault Systèmes</p> 	<p><b>Charlie Chen</b> Division Manager of Industrial &amp; Mobile Application, Bosch Rexroth Taiwan</p> 
<p><b>Jay Lee</b> Professor, University of Cincinnati</p> 	<p><b>Catherine Lu</b> TV Journalist Business Next Media Corp</p> 	<p><b>Cyrille SCHWOB</b> Head of Technology, Asia-Pacific, Airbus</p> 	<p><b>Fan-Tien Cheng</b> Director, Intelligent Manufacturing Research Center, National Cheng Kung University</p> 



## S.E. Asia Leads Machine Tools Market

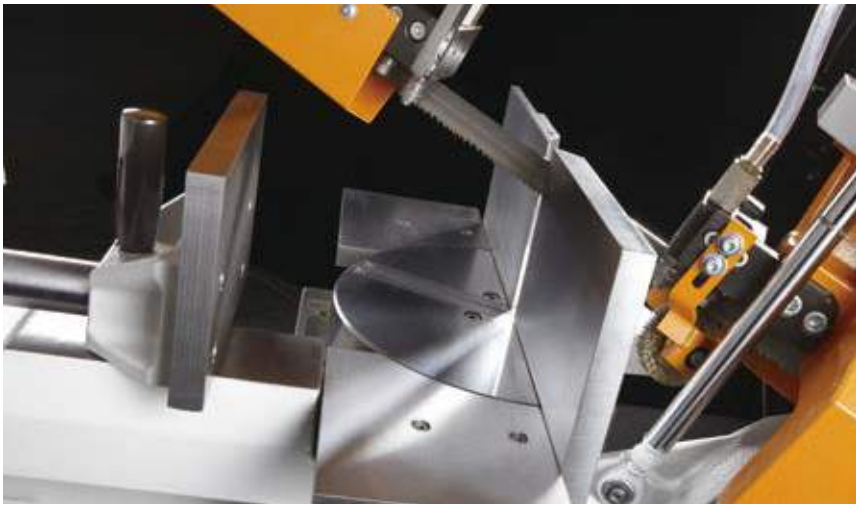

According to a new market research report published by Credence Research, the global machine tools market is set to hit US\$120 billion mark by 2026. The overall machine tools (metalworking equipment) market is highly governed by the continually rising industrial manufacturing

and processing sector worldwide.

Asia Pacific estimated to remain the frontrunner in the market throughout the forecast period with strong industrial sectors across South East Asia. The region has portrayed tremendous growth in industrial manufacturing sector since the past few

decades, making it the largest consumer as well as producer of machine tools (metalworking equipment).

On the basis of product type, the machine tools market is led by metal cutting segment accounting for more than 60% of the total market value. The segment comprises machine tools such as drilling & boring, lathe, milling & machining centers, grinding, lapping, honing & polishing machines and others. Based on industry verticals, automotive, consumer goods manufacturing and machine tool & parts manufacturing represent the most promising segments. Further, based on geography, the market is segmented into North America, Europe, Asia Pacific and Rest of the World (RoW). The market is currently led by Asia Pacific owing to factors such as huge industrial sector and large number of machine tools manufacturers. The market here is mainly backed by China

and Japan. With rapidly growing industrial manufacturing sector in India and South East Asia, the region would also exhibit the highest growth rate during the forecast period.

The overall machine tools market is quite fragmented in nature with presence of numerous international as well as regional players. This has ensured a competitive environment for the market players. New product development is one of the most prominent strategies adopted by the major market players. Due to consistently increasing penetration of CNC machines, most of the companies strive to develop more sophisticated automated products in order to maintain a competitive edge. In addition, expansion of distribution network is another prominent strategy adopted by the market players. ■

Source: Int'l Metalworking News for Asia

## Metal 3D Printer Market to Reach Net CAGR of 24.7% by 2026

The global metal 3D printer market is projected to register a CAGR of 24.7 % in terms of value over the forecast period. The report offers in-depth insights, revenue details, and other vital information regarding the global metal 3D printer market, and the various trends, drivers, restraints, opportunities, and threats in the target market till 2026.

Metal 3D printers enable rapid prototyping and additive manufacturing, to produce three-dimensional products, using digital model data from a 3D model. As opposed to subtractive manufacturing, these printers facilitate additive manufacturing by laying down successive layers of material.

Among the product type segments, the powder bed product type segment in the

global metal 3D printer market is expected to register a CAGR of over 25% over the forecast period. Its ability to print complex shapes with geometrical accuracy of +/- 0.05 mm is among some of the primary factors driving high adoption of powder bed type 3D metal printers.

Among the application segments, the automotive segment is projected to register highest CAGR of over 26%, owing to increasing demand cost-effective manufacturing process for production of lightweight automotive parts. The medical application segment accounts for considerable revenue share and is expected to follow the automotive segment in terms of revenue growth in the global market during the next 10 years.

Increasing adoption of metal 3D printers for manufacturing medical instruments is one of the major factor driving growth of

the medical segment. ■

Source: Int'l Metalworking News for Asia



## The Industry 4.0 Market Worth US\$214B by 2023

According to the report by HSRC, the Industry 4.0 market is forecasted to reach \$214 billion by 2023, dominated by global technology giants including Alphabet-Google, HP, Samsung, IBM, NEC, Microsoft, and more.

The Industry 4.0 market race is led by the global tech giants that invest billions of dollars in Industry 4.0 products R&D, M&A, commercialization and internal use. Furthermore, these companies have acquired smaller technology companies, especially in the AI sector, to strengthen their industry 4.0 capabilities.

Industry 4.0 holds immense potential. Smart factories allow individual customer

requirements to be met, meaning that even one-off items can be manufactured profitably. In Industry 4.0, dynamic business and engineering processes allow last minute changes to production and deliver the ability to respond flexibly to disruptions and failures on behalf of suppliers.

End-to-end transparency is provided over the manufacturing process, facilitating optimized decision-making. Industry 4.0 will also result in new ways of creating value and novel business models. It will provide start-ups and SMEs with the opportunity to develop and provide downstream services.

The Industry 4.0 competition is not

only about technology or offering the best products; it is also, and in particular, about the companies that collect the appropriate data, combine it to provide the best digital services, and utilize it for their own benefit. Those who know what the customer wants, and can forecast consumer demand, will provide the information to develop an "unfair" competitive advantage.

The major winners might be those that control "Industry 4.0 Platforms", software layers that syndicate various devices, information and services, on top of which other firms can build their own offerings.

According to the report, the Industry 4.0 revolution will be driven by an ensemble

of emerging technologies, such as Industrial Internet of Things (Industrial IoT), Big Data analytics, advanced industrial robots, Artificial Intelligence (AI) and predictive maintenance. In the next decades, businesses, led by the giant tech companies, will establish global networks that incorporate their machinery, warehousing systems, and production facilities in the shape of cyber-physical systems that can be managed in real time. These extremely flexible value networks will require new forms of collaboration between companies, both nationally and globally. ■

Source: Int'l Metalworking News for Asia



# ASIA'S ONLY PROFESSIONAL 5-AXIS MACHINE CENTER MANUFACTURER



KEN CNC is the only company that specializes in 5 axis gantry machine centers for the aerospace and automotive industries.

We integrate European key components with Taiwanese professional team, to satisfy the needs of following industries

-  **Aircraft Industry**
-  **Automotive Industry**
-  **General Machining Industry**

## HIGH SPEED

**FEEDRATE:60 M/MIN**

## HIGH TORQUE

**MAX. TORQUE : 1,200 NM**



### Focus5

#### 5-Axis Double Column Machine Center

- High rigidity one piece column and crossbeam structure
- X/Y - axis linear motor drive
- Direct-drive motor two-axis milling head



### SABER

#### Double Column 5-Axis Machining Center

- European high torque 2-axis milling head with high torque spindle
- High rigidity one-piece base and column
- Z-axis movement by two high rigidity box-way
- Suitable for high titanium materials of aerospace industry



### COMPACT B

#### Gantry Type High Speed 5-axis Machine Center

- Gantry type
- Box-in-Box symmetrical design
- Column and base one piece design
- X/Y - axis linear motor drive
- Direct-drive motor two-axis milling head



### TITAN

#### Double Column 5-Axis Machining Center

- Z-axis moving crossbeam
- One-piece h-type column structure
- European imported high torque 2 axis milling head
- Heavy duty roller type linear guideway
- Suitable for high titanium materials of aerospace industry



### LinMAX B

#### Gantry Type High Speed 5-axis Machine Center

- Gantry type
- Box-in-Box symmetrical design
- Column one piece design
- X/Y - axis linear motor drive
- Direct-drive motor two-axis milling head
- Modular design milling head



### RHINO

#### Horizontal 5-Axis Machining Center

- Cross beam moves up and down, milling optimal rigidity
- One piece H type column
- Hydrostatic rotary table
- Short throat depth tilting milling head





## Kenturn: Reliable Spindle Expert for CNCs

The main products that Kenturn reveals at TIMTOS this year are spindles applied for the grinding machine, multi-purpose CNCs, and special purpose CNCs. Deriving from a continuation of manufacturing exception quality of built-in spindles, belt-drive spindles, and inner bore grinding spindles, The company optimizes the speed and accuracy of spindle performance while putting the clients' demand first. For example, Kenturn introduced swing head spindle which combined high stability/accuracy performance with intelligent vibration monitoring and sensing system. Benefiting from this system, the data during the processing can be sent to the operator instantly as well as the self-diagnostic of the spindle can occur continuously to ensure good pre-troubleshooting.

Recently, it has also developed a series of cutting tools, with brand name ECIO. It



provides solid carbide end mills, suitable in assisting cutting difficult-to-machine materials. ECIO cutters have included nearly 1000 categories so far. The main precision cutters are tungsten steel end milling cutter, tungsten steel ball cutter, tungsten steel round nose cutter, tungsten steel forming cutter and tungsten steel taper cutter.

In regards to its future developmental strategy, Kenturn will continue on their core value of being innovative and flexible, especially when responding to the prevailing trend of Industry 4.0 and automation. The company's spindles will become even-more important for CNCs to operate smoothly and reliably without human inspection. Kenturn will also enhance their outstanding spindle features, which could inhibit heat and assist thermal deformation.

The company has a solid strategy for the international market. With versatile and customized R&D capabilities, it can fully respond to the needs of various market changes. Regarding the future market strategy, it will continue to develop high-quality, low-error-rate spindles in assisting machine tools to run smoothly, which would significantly contribute to extending the life of CNC machines. In addition to bringing



more efficiency to the production line, Kenturn would incorporate the strengths of spindles to the mechanical system and elevate the capacity of automation and intelligent spindles. Kenturn will keep on the company's R&D strength, and improve the level of operational stability, prolong tool life. These attempts will actively be engaged with the concept of intelligent manufacturing while providing reliable and highly efficient spindles for machinery.

Under the intelligent manufacturing

theme of TIMTOS 2019, Kenturn showcases their strong and efficient spindles, which thrive to empower the entire future of high speed, CNCs, mechanical technology and a new era of versatile and smart manufacturing.

**Kenturn Nano. Tec. Co., Ltd.**

Tel: +886-4-7910-271

Fax: +886-4-7910-272

E-mail: [cnc-spindle@kenturn.com.tw](mailto:cnc-spindle@kenturn.com.tw)

Website: [www.kenturn.com.tw](http://www.kenturn.com.tw)

**Booth No.: Q0804**

## DEES: Efficient 2,500-ton Tandem Line Customized for Automotive Manufacturing Industry

Known for its high quality and precision hydraulic machines, DEES attends this year's TIMTOS show with introducing a 2,500-ton Tandem Line customized for automotive manufacturing industry.

According to Mr. Ale Lee, Sales Manager of DEES Hydraulic Industrial Co., Ltd., the monoblock of hydraulic system is easy to maintain and powered by the motor and pump set. Moving bolsters with Q.D.S. system (quick die change system) to make the heavy die change easier and faster. The production line is automatically working all year round, 24 hours a day. Users can adjust its pressures, speeds, daylight and stroke distances, according to special production requirements. The user of this automobile stamping production line, FORD, possesses more than 10% of the world market share, and it is one of the world's top 3 automobile manufacturers.

Nowadays, the products in the field of automobile stamping are becoming more and more refined, automatic and computerized. The high-speed technology of HD series developed by DEES, is controlled by the accumulator. Its pressing speed is between 30 to 150 mm/sec, with

the approaching speed of 800 mm/sec or faster and return speed of 600 mm/sec or faster. With function of cushion system to knock out the parts, all speeds and strokes including the slide and cushion systems can be adjustable. The DEES self-developed HD-FASTech technology solves the deep-drawing's low efficiency, greatly improving production efficiency.

DEES, founded in 1976, is specialized in the production of large hydraulic machinery in Asia, unmanned production line and all kinds of hydraulic press, hydraulic folding bed, hydraulic shears the important manufacturers, after more than 40 years of growth and development of the company in line with the "Reliable quality, on-time delivery, efficient service" business philosophy, and a consistent manufacturing philosophy for clients is "complete engineering, manufacturing and solutions". In addition to its years of manufacturing experience and continuous exchanges and communication with the advanced technology of Europe and the United States, now DEES has a high degree of design and manufacturing technology, strict quality control system

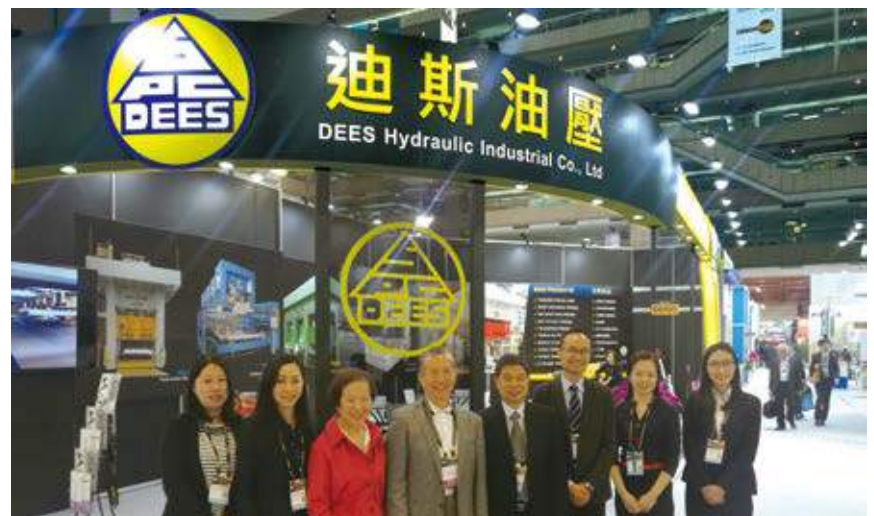

and excellent after-sales service function, the company has passed ISO-9001 quality certification and CE safety certification, to provide customers with a safe and easy-to-use interface.

DEES Hydraulic offers best quality of hydraulic presses to automotive Industries for manufacturing body panels, chassis and car parts with capacity of 10 to 6,000 tons which the largest bolsters size reaches 13 meters in length. In the 2,000 tons tandem press line with YASKAWA Robotics, Left & right moving bolsters are an efficient tool for exchanging heavy dies. The design of this

automotive line and automation solution is integrated by DEES Hydraulic.

DEES supplies customers such as Bombardier, Boeing, Honda, Toyota, Audi, Volkswagen, Mercedes-Benz, Volvo, Bosch Group home appliances, Electrolux, GE home appliances, Haier, Foxconn, etc. DEES has supplied more than 4,500 customized hydraulic presses worldwide.

**DEES Hydraulic Industrial Co., Ltd.**

Tel: +886-2-2601-8661

E-mail: [sales@spc.com.tw](mailto:sales@spc.com.tw)

Website: [www.deesgroup.com.tw](http://www.deesgroup.com.tw)

**Booth No.: D0401**





## Every Spindle

is tested up to **72 Hours**

Using state of the art instruments . Precision assembly techniques must pass High-Reliability test. The most advanced machinery finishing equipment feature-ing the best of western technology and own decades of finishing and manufacturing experience.



## CUSTOMIZATION

Help you improve the performance of processing equipment best companion.

## SPINDLES REPAIR

Provide a variety of domestic and foreign machine tool spindle service.



CNC Machining Center Spindle



CNC Turning Center Spindle



CNC Grinding Spindle



Special Machine Spindle



**KENTURN**  
**ECIO**

ECIO易上手 好用好上手  
The ideal option for efficient cutting

**T** +886-4-7910-688

**F** +886-4-7910-272

**E** [ecio@kenturn.com.tw](mailto:ecio@kenturn.com.tw)

**W** [www.kenturn.com.tw](http://www.kenturn.com.tw)

難切削材刀具 / 客製特殊刀具



**Kenturn Nano. Tec. Co., Ltd**

☎ +886-4-791-0271    📠 +886-4-791-0272

✉ [cnc-spindle@kenturn.com.tw](mailto:cnc-spindle@kenturn.com.tw)

🌐 [www.kenturn.com.tw](http://www.kenturn.com.tw)

📍 16E.7Rd., Chang Bin Ind. Park, Shian shi, 50741 Chang Hua, Taiwan





## YINSH: To be the World's Leading Parts Supplier



In TIMTOS 2019, YINSH brings its new "Axial Force Sensor", which is specially designed for the precision nut

of the spindle. Its function is to measure the torque of the precision nut when it is locked. In addition, it can also check

whether the quality of the spindle is stable during the process. This product is currently available in three sizes and the special axial washer can be used to measure axial force maximum to 4000kgf.

YINSH has focused on the manufacture and sales of "precision locknuts" for a long time. Their main products are: Superfine balance locknut, YSPL series precision locknut, hydraulic nut, Superfine Grinding Locknut, YS series precision Locknuts. All these products are widely used in high-speed machine tool spindles, woodworking machines, printing machines and other equipment.

YINSH is now focusing on high-precision production equipment, and has built the first "Precision Locknut Inspection

Lab", which is committed to providing no-defect, high-quality products and services to more users.

Established in 1989, Taichung-based YINSH started from a traditional small factory. After 20 years of growing, it has formed a large Taichung manufacturing base and a global marketing service center. In the road of upgrading, the company adheres to the concept of "quality first and service first" and is striving to become the world's leading parts supplier.

**YINSH Precision Ind. Co., Ltd.**

Tel: +886-4-2244-7899

Fax: +886-4-2245-2402

E-mail: [service@yinsh.com](mailto:service@yinsh.com)

Website: [www.yinsh.com](http://www.yinsh.com)

**Booth No.: Nangang Hall 2, R0814**

## GREENWAY: Multi-tasking CNC Lathes Promote Unmanned Factory

Jarng Yeong Enterprise, known by its brand name GREENWAY, is exhibiting Turning & Milling Complex Type CNC Lathe (HCP-42), Special Purpose Machine (HC-30N), CNC Lathe with Articulated Robot (HCP-42) and CNC Lathe with Gantry Loader (HC-30) at TIMTOS 2019.

The HCP-42 Turning & Milling Complex Type CNC Lathe meets the demands of high versatility production. It's optional to choose 42# collet or 6" 3-jaw hydraulic chuck. Aside from that the HCP-42 has various optional accessories, such as gear hob live tool device, hydraulic or servo turret, single shaft side milling device, Y-axis 4 shafts/8 shafts side milling device, 3 shafts drilling or tapping device and polygon milling devices, etc. As C-axis function (optional), it can be applied on the control of random spindle positioning angle and (workpiece turning) profile. Therefore, processing side/end milling, eccentric drilling and outer diameter turning are available. It can be configured by the processing demand of customers.

The HC-30N Special Purpose Machine adopts a boxway, and one-piece casting body, weights only around 1,700 kg. It is categorized as a small sized machine, but suitable for middle/heavy turning tasks. With X/Z axis extended travel design, the equipment maintained incomparable stability during machining. In addition, it is forwarded into automation SPM to increase production efficiency. At Timtos, the company demonstrates the customized single workpiece auto feeding system with HC-30N, in line with demands for automation.

The HCP-42 CNC lathe with articulated robot machines highly diverse products in small batches. Jarng Yeong cooperates with its supplier to provide a complete automated

articulated robot to increase efficiency and avoid human error, which are prerequisites for unmanned factory.

The JYN-42 CNC lathe can be equipped with a gantry loader to make single workpiece auto feeding, and double axis servo control. It enhances the production efficiency and expands quality level. Meanwhile, it saves labor cost and realizes high-speed operation. Based on different demands for blank material feeding, the option includes material flip station, rotary lifting workpiece station, pallet type work feeder station and vibration barrel work feeder station to change and feed materials.

### Highly capable of creating practical solutions

GREENWAY's overseas auto parts customer initially produces around 5 million pcs annually, and executes OEM via Swiss type CNC lathe. Yet the unit price of the machine is expensive, and requires long cycle time that resulted in a high cost. After cooperating with GREENWAY, the company assisted them to develop customized punching device installed on HC-series CNC lathe. Currently, there are 15 lathes in the customer's factory and the manufacturing cost has been successfully reduced 50%, with the advantages of doubling productivity. This case is the positive result for manufacturers in breaking the limit of OEM, and gain more power of controlling the productivity and cost in their own hands.

### Auto feeding feature moving towards automation

The company's performance in 2018

was affected by the Turkish currency crisis. The consumer market is still surviving the recession, in which Jarng Yeong was affected due to its reliance on export. Therefore, the company plans to expand its domestic demand market.

With the increasing salary annually, the younger generation prefer not to work in traditional manufacturing facilities. Thus, the situation is turning to Industry 4.0, which becomes a global focus. Moreover, the requirement for automation equipment is expected to accelerate. Jarng Yeong aims to improve its modular auto feeding

the core and continue to design and develop new models. The company is always keeping the quality of its products, focusing on lathe design and research, and refining the importance of its lathes to establish GREENWAY's brand value.

**Brand Remodeling:** Established nearly for 40 years ago, Jarng Yeong is known for its professionalism and enthusiasm and widely acclaimed. For MIT brand being rooted in international market, the company built its own brand, "GREENWAY" in 2011, hoping to break the traditional impression and bring a new



by customization to save cost and delivery time and also solve the problem of long term shortage of man power. Hence, GREENWAY is anticipated to continue developing robustly in Turkey and Russia markets, and extend its reach to Southeast Asia and Middle East.

There will be three major plans for Jarng Yeong: Equipment Improvement, Brand Remodeling and Sustainable Development.

**Equipment improvement:** In response to the rapidly changing market and customer requirements, Jarng Yeong is continuously improving its equipment. The company mainly focuses on customer's demand as

style into traditional manufacturing and to continue selling machines all over the world.

**Sustainable Development:** Jarng Yeong aims to be a professional lathe manufacturer that offers the most advanced, stable quality and the most reasonable price. Jarng Yeong is strongly dedicated to be a long-term manufacturing company with reliable technology and production capacity.

**Jarng Yeong Enterprise Co., Ltd.**

Tel: +886-4-2615-2157

Fax: +886-4-2615-2161

E-mail: [greenway@cnc-lathe.com](mailto:greenway@cnc-lathe.com)

Website: [www.cnc-lathe.com](http://www.cnc-lathe.com)

**Booth No.: Nangang Hall 1, L0326**



# Sensors in Industry 4.0



**T**he adoption of Industry 4.0 concepts in South East Asia is growing as industries are realizing the potential efficiency and productivity that can be garnered with the applications of Industrial IIoT.

Recently, Mercedes-Benz constructed a truck assembly line for Daimler Trucks, its successful commercial vehicles manufacturer, using the Industry 4.0 concepts of hyperconnectivity and digital technologies. The production lines consisted of a number of sensors, especially light sensor technology in forklifts to facilitate the materials flow. With a 15% improvement in manufacturing efficiency, Mercedes-Benz has decided to extend the concepts of Industry 4.0 to all its production processes of major assemblies. The sensors would be a huge part of this provident implementation by Mercedes-Benz.

The adoption of Industry 4.0 concepts is growing as industries are realizing the potential efficiency and productivity that can be garnered with the applications of Industrial Internet of Things (IIoT). This could result in colossal upsurge for the global sensor market. The sensors in industrial control alone are expected to generate revenue of \$4,101.1 million by 2021.

## Market Applications of Industry 4.0 and Role of Sensors

The market applications of Industry 4.0 concepts range from factory automation to agile production lines, smart manufacturing to retail inventory control and supply chain.

As the industries are looking for self-optimized and automated manufacturing systems, data collection and analysis at lowest field levels hold the highest priority. This provides lucrative market prospects for sensors as they are the enablers of the IIoT concept in the industry.

## Industrial Process Control

The industrial control applications segment accounts for the highest market share for sensors at 38.6%. Process control applications in the industry require the close monitoring of variables for level, pressure, temperature, flow, etc. With Internet of Things, sensors enable continuous monitoring and control of the industrial processes. More than 20 different sensors are deployed in the IIoT industries for industrial control owing to their remote sensing and monitoring capabilities.

The Sensors 4.0, i.e. smart sensors, allow for data collection and analysis through cloud and IO link interfaces, enabling continuous monitoring and maintaining optimum industrial conditions. Sandvik Coromant, a leading service supplier for metal cutting industries, moved from in-process to in-tool sensors to control its cutting processes throughout. This process control used embedded sensors inside the company's Silent Tools that enabled monitoring of process parameters such as tool deflection, cutting forces, tool load, and temperature for insight on the machining process. The sensors were adopted with the vision to reduce scrap rates and improve productivity.

The market scope for sensors in process and condition monitoring is huge as industries are shifting toward in-process sensors as a control strategy. Sensors will soon be widely adopted by automotive, aerospace, and manufacturing industries for process control. Process control applications in industries are expected to dominate the sensor market with a compound annual growth rate (CAGR) of 15.8% over the coming years.

## Automation and Agile Production Lines

Sensors will have key growth

opportunities to leverage IIoT for advanced automation of processes in the manufacturing environment. Automation in production lines is possible only with the sensors that are capable of collecting data and analyzing it for efficient decision making that enables self-optimization. The wireless smart sensors market, worth \$502.2 million in 2016, has end users investing in industrial automation as companies are gearing up for the Industry 4.0 revolution.

Factory automation allows for customized product solutions as well as self-optimization of the production lines. Traditional conveyer manufacturers are already incorporating sensors and radio frequency identification (RFID) to enable new features and capabilities. Mitsubishi has decided to invest more than ¥30 billion to boost its factory automation system. The leading industries are vying to gain maximum advantages from automation through Industry 4.0, which delivers ample prospects for the sensors market.

## Digitalized Supply Chain and Logistics

Sensors lie in the forefront of the supply chain market to leverage the IIoT capabilities, with 44% of supply chain organizations

already using them. Sensors in the logistics market are currently recording a CAGR of 15.9% owing to their improved asset tracking and remote monitoring abilities. Temperature sensors, proximity sensors, vibration sensors, RFID tags, etc. ensure the monitoring and transparency of assets in all levels of the supply chain.

Nokia has already applied a Conscious Supply Network concept at factories to leverage digitalization across its supply chains. This won Nokia the Supply Chain Management Award in 2015. The application of Industry 4.0 in supply chains is growing, and adoption rates for sensors in supply chain will predictably rise. Johannes Giloth, Senior Vice President of Global Operations at Nokia, explained the company's strategies of putting thousands of sensors in the factories to connect manufacturing and logistics assets for ensuring visibility throughout the manufacturing and logistics value chain.

As the industries are moving toward smart manufacturing with Industry 4.0, the need for optimized logistics and efficient supply chain has become an increasing necessity. The adoption of asset tracking solutions by the industries is expected to register high growth in the next five years. The supply chain industry is highly dependent on asset tracking solutions and technologies for optimized supply lines and reduced time to market (TTT), which routes to a high demand for the sensors market.

## Conclusion

The major arenas for Industry 4.0 market applications imply a significant growth potential for the sensors market in South East Asia. Sensor deployments in the areas of process control, automated production lines, and digitalized supply chain is slated to increase in the coming years. Sensor technology leverages fully enabled connectivity and data sharing and integration with logistics, and hence the sensor market will experience high adoption rates in Industry 4.0 market applications in next five years. ■

*Source: Int'l Metalworking News for Asia*







# 盈錫積極邁入智慧製造 生產模式滿足客戶少量多樣的需求

盈錫為國內知名的工具機零配件精密螺帽製造商，全力建構智慧化工廠，讓產品更加滿足客戶需求。



專利號  
I262262  
I385314  
I427279



YS

YSPL

歐美日等工具機大廠 ▶ 精密螺帽及精密零件主要供應商

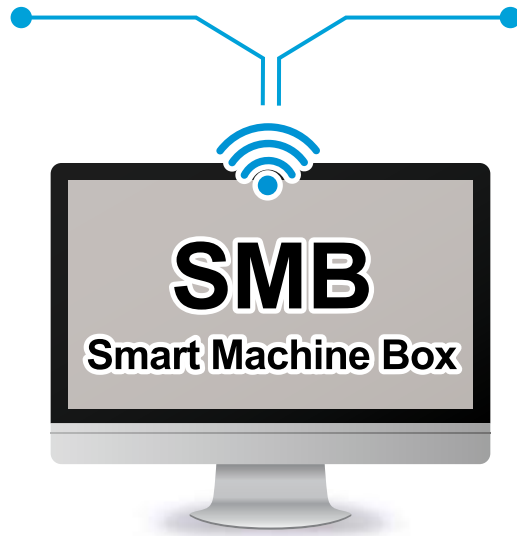

**戰情室**  
電子互動資訊看板

**Robot + AGV**  
智能化機電整合應用

**MES**

**ERP**

**AI** 智慧圖面報價  
輔助系統

**TIMTOS** 南港2館  
2019 March 4-9  
第27屆台北國際工具機展覽會  
R0814



盈錫精密工業股份有限公司 YINSH PRECISION INDUSTRIAL CO., LTD.

www.yinsh.com  
www.yinsh.hdv.tw

電話：+886-4-2244-7899  
傳真：+886-4-2245-2402

信箱：service@yinsh.com  
地址：台灣台中市北屯區崇德六路一段31巷26號





# 2019 RINGIER MANUFACTURING AND PROCESSING INDUSTRY SUMMIT

## CHINA MARKET

- ◆ High-efficiency Machining Intelligent Automation Summit 2019 | 06-07 MAR, Chongqing
- ◆ Foshan High-efficiency Processing Manufacturing Technology Summit 2019 | 11 APR, Foshan
- ◆ High-efficiency Machining Conference 2019 - Beijing | 14-15 APR, Beijing
- ◆ Difficult Processing Materials High-efficiency Processing Manufacturing Technology Forum 2019 (customized Conference) | 15 APR, Beijing
- ◆ High-efficiency Machining Conference 2019 - Nanjing | 22 MAY, Nanjing
- ◆ The Mold Technology (Ningbo) Forum 2019 | 30 MAY, Shanghai
- ◆ 2019 Global Laser Processing Technology Summit | 06 JUN, Shanghai
- ◆ The 6th Mould High Efficiency Manufacturing Technology Summit 2019(semi-customized Conference) | 10-11 JUN, Shanghai
- ◆ Global Smart Factory Summit 2019 | 28 JUN, Shanghai
- ◆ Implantable & Interventional Medical Device Manufacturing & Technology Conference 2019 | 8-9, AUG, Suzhou
- ◆ The 2nd New Energy Vehicle Manufacturing Conference 2019 | 04-05 SEP, Shanghai
- ◆ China International Internal Combustion Engine Advanced Manufacturing Technology Summit 2019 | 06 SEP, Suzhou
- ◆ China International Internal Combustion Engine Advanced Manufacturing Technology Summit 2019 | 17-18, OCT, Suzhou
- ◆ 2019 China Intelligent Laser Manufacturing Technology Forum | 24 OCT, Shenzhen



## S.E. ASIA MARKET

- ◆ ASEAN Automotive & Motorcycle Parts Manufacturing Summit | 02-03 APR, Hanoi Vietnam
- ◆ India Automotive & Motorcycle Parts Manufacturing Summit | 16-17 JUL, Pune India
- ◆ ASIA Plastics Processing Technology and Innovative Materials Summit 2019 | 29-30 AUG, Jakarta Indonesia
- ◆ ASEAN Automotive & Motorcycle Parts Manufacturing Summit | 05-06 NOV, Jakarta Indonesia



Registration, sponsorship consultation and details Information request, please scan the QR code

 **Ringier Events**  
Connecting industry through information exchange!

[www.ringierevents.com](http://www.ringierevents.com)



# 緊盯著您的刀具



**mida** ULTRA PRECISION PROBING

當今日對於精確的需求已達到極限之時, **Marposs Diamond System** 創新突破重新定義機上工件量測規則。

**VOP 40 Diamond** 測頭能夠給予最優的檢測功能, 即使是極其複雜的工件或 3D 表面, 甚至在最小型的機台, 也可確保精確的高品質與減少不良品的產生。



**MARPOSS**

您全球的合作夥伴

[www.marposs.com](http://www.marposs.com)

**馬波斯精密股份有限公司**

台中市南區復興路二段120-3號4樓

Tel. +886-4-2262-2340 Fax. +886-4-2262-2402



## Exhibit Highlights

### Drive Shaft

Types: Universal Joint-TYL\TYB\TYB-S Series

Functions:

1. Rubber Sheet Machines in Rubber Plant

2. Pressing Rollers in Steel Mill

Features :

1. Angular displacement shaft up to 15 degrees

2. High loading capacity

3. Flexible length

4. Three types selection : Light load, Medium load, Heavy & Super heavy load cases of use.



**TIEN YI Gear Works Co., Ltd.**

Tel: +886-3-5970-206

Fax: +886-3-5970-210

E-mail: sales122@tienyigear.com.tw

Website: www.tienyigear.com.tw

Booth No.: G0231

### 5-Axis Machining Center

The U6 is a collection model of high-precision, high-speed, high efficiency and high-tech control technology in one, it also has the best cost performance ratio. Its design concept is through a stable standardized machine and high-reliability swivel rotary table integrated structure, B/ C axis are equipped with linear scale to improve the precision of machining quality. Its excellent performance is your best choice into the field of five-axis machining.

High efficiency: It is equipped with Siemens 840Dsl high-performance controller can be applied from simple to complex five-axis simultaneous machining.

High precision: X/Y/Z three-axis linear guideway + B/C axis to install high-precision linear scale/encoder; B-axis tilting range +90°-120°; C-axis rotating range 360°; B/C axis table horizontal loading capacity 300KG.

High-speed & high-torque spindle: 12,000 rpm direct drive, torque up to 60NM

Large-capacity magazine: Chain-type ATC can load 32 tools.

**MASTER Automatic Co., Ltd.**

Tel: +886-4-2525-0480\*202

Fax: +886-4-2525-7747

E-mail: claire@macocnc.com

Website: www.macocnc.com

Booth No.: K0322



### Tandem Press Line

Through LCH exclusive HMI control, LCH Tandem press line is able to process



part(s) from blank to finished stamping with a set of dies. With automation, the blank washing and stamping process is done automatically increasing productivity and reduce labor costs.

Features:

1. 3D vision system

2. 6 axis robotic arms at every station

3. Robot automatic feeding system

4. High quality plate washer

5. Fully automatic

6. Increase productivity

7. reduce man-power

**LIEN CHIEH Hydraulic Industrial Co., Ltd.**

Tel: +886-2-8648-3000

Fax: +886-2-8648-2000

E-mail: michael\_wang@lch.com.tw

Website: www.lch.com.tw

Booth No.: D0501

### Metal Sander

RDB-06 model: Going with 2 grinding heads that can rotate 180° and be changed with different grinding brushes, removing the burr on the work piece rapidly, which is quite suitable for machining after laser cutting. The work table can be installed with magnetic disc to attract iron material or you can also choose the vacuum cup to fix the thinner work piece.



Features:

1. Rapid & easy-Easy to change the sanding belt and brush without wasting time.

2. Convenient to operate-Ergonomic design helps to decrease the consumption of labors' energy greatly.

3. Efficiency enhancement-Production procedure is made smooth and efficient, making the quality of products much better.

**Sheng Yu Machinery Co., Ltd.**

Tel: +886-4-2522-0948

Fax: +886-4-2522-0648

E-mail: w1954@ms21.hinet.net

Website: www.worldmax.com.tw

Booth No.: M0606

### Press Blanking Line

Shung Dar's Press Blanking Line is specially designed for the high-quality demands of the automotive and fabricating industries, providing total processing solution for steel coil blanking and blank stacking operation, with Siemens servo control drive system, and modularized mechanism, enabling highly automated production line, including auto coil loading, threading, and stacking. Production line parameters are database controlled, mechanical action adjustments can be simply executed simultaneously via data downloading and confirmation, providing outstanding operator safety and operation efficiency. Multiple coil carts, and dual stacking system, makes zero machine downtime possible, ensuring safety preparation at maximum operation.

In addition, lines using this technology are ideally equipped to process the widest variety to material, such as aluminum or high-strength steel. Even surface-sensitive material can be processed safely on the same line at the highest production rates.

With its plentiful R&D technology and experience in the field of auto stamping feeding equipment, Shung Dar has established a new international competitiveness on the blank stamping facility manufacturers in Taiwan.

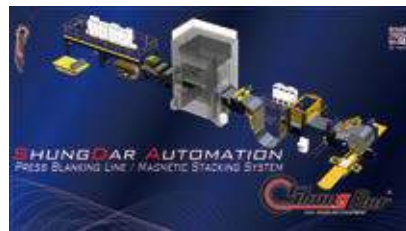

**SHUNG DAR Industrial Co., Ltd.**

Tel: +886-4-7622-020

Fax: +886-4-7622-022

E-mail: shungdar@ms17.hinet.net

Website: www.shungdar.com.tw

Booth No.: C0310

### Indexable Saw Blade

1. Mainly used for side milling application. It is suggested that smaller the diameter cutter better the performance of the tool. If the small diameter cutter used, it will give better stability and increase insert tool-life.

2. Single cutting edge and patented chip removal design will reduce machining resistance.

3. Our special grade insert CE60 is oxidation and wear resistant.

**YIH TROUN Enterprise Co., Ltd.**

Tel: +886-2-8521-3035

Fax: +886-2-8522-3039

E-mail: a003@cut-tools.com.tw

Website: www.cut-tools.com.tw

Booth No.: A0424



### Under Drive High Speed Press BT-10

BT-10 high speed presses are widely used in:

1. Secondary process for lead frame

2. Clean print sheet

3. Flexible print circuit board

4. Not metal material

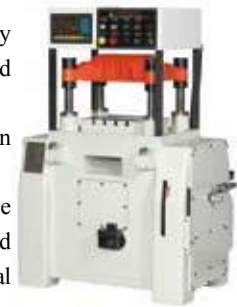

The machine is designed for the operator convenience with computer control system, brake and error correction display on screen.

It also has high tensile cast iron stress relieved for maximum rigidity and longtime accuracy. Besides, the mechanism is suitable in non-metal material working, because it is non-oil on stamping parts.

**LI YE Machinery Co., Ltd.**

Tel: +886-2-2207-1818

Fax: +886-2-2207-1919

E-mail: info@liye-presses.com

Website: www.liye-presses.com

Booth No.: D0618

### Servo Drive Table Top Broaching Machine

1. The machine equipped with servo motor and ball screw, consistence broaching speed, low vibration, increase tool life over 20%.

2. Compare with traditional hydraulic machine, the electrical mechanical design save over 40% electricity and keep floor clean.

3. HMI interface is convenient for operator to operate the machine and diagnose the machine.

4. Adjust the broaching speed and stroke through HMI.

5. Automatic broach tool puller & retriever for tool change.

6. No pit needed for electrical mechanical broaching machine, easy for automation.

7. The broach tool retriever will reduce the tool vibration.

8. One-piece machine enclosure meets CE safety requirement, easy to maintenance.

**AXISCO Precision Machinery Co., Ltd.**

Tel: +886-49-2511-395

Fax: +886-49-2512-970

E-mail: info@axisco.com.tw

Website: www.twaxisco.com

Booth No.: L1230





### Gantry type High Speed 5-Axis Machine Center

Compact B Gantry Type High-Speed 5-Axis Machine Center is the expert for automotive mold and die making.

Box-in-Box symmetrical design minimizes the thermal displacement and ensures excellent precision during working hours.

One Piece structure design improves the overall structural rigidity and betters the stability of precision and mechanical performance.

Linear Motor Drive provides the machine center high speed, high acceleration, and high accuracy.

Direct-Drive Motor 2-axis Milling Head is free of wear; therefore, it is easier for maintenance and has better long-term accuracy.

The milling head has especially longer spindle extension 200mm and 185mm, which is suitable for deep cavity milling and reduces interference range.



**KEN ICHI Machine Co., Ltd.**  
 Tel: +886-4-2565-3080  
 Fax: +886-4-2565-3090  
 E-mail: info@kencnc.com  
 Website: www.kencnc.com  
 Booth No.: I0616

### 100kVA Automatic Relieve Valve Welding Machine

Suitable for oil filter makers and automotive part makers.

Features:

- Automatic machine able to assemble and weld the relieve valve assembly.
- Springs are separated and fed to the welding station automatically.
- Three Phase DC Inverter Welding Machine ensures excellent and strong weld quality.

**DAHCHING Electric Industrial Co., Ltd.**  
 Tel: +886-6-593-2646\*19  
 Fax: +886-6-593-5555  
 E-mail: lily@dahching.com;  
 service@dahching.com  
 Website: www.dahching.com/en  
 Booth Number: C0938

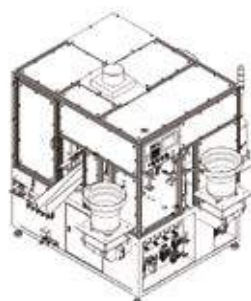

### Micro Electric Power-off Brakes

Chain Tail Co., Ltd. has developed new Micro Electric Power-off Brakes of Spring Applied Brakes and Permanent Magnet Brakes. The minimized static torque is of 0.04Nm and the diameter is smaller than 20mm. With custom-made installation method, the clients have more flexible selections on various applications.

With the compact, power-saving advantages as well as over-heating prevention features, Micro Electric Power-off Brakes are frequently inquired

on applications of robotic arms and AI purposes.

Especially for Permanent Magnet Brakes, the permanent magnets inside are with the function as that of springs' in spring-applied brakes. Functioning with armature plates and springs, Permanent Magnet Brakes are with zero backlashes when power is cut off, and with no drag torque when power is on.

**CHAIN TAIL Co., Ltd.**  
 Tel: +886-4-2335-3024  
 Fax: +886-4-2335-4027  
 E-mail: ct.salestw@msa.hinet.net  
 Website: www.chaintail.com  
 Booth No.: S1414





**POSA**  
www.posa-spindle.com



**Pioneer of Spindle Area  
 26 Years Advancing Technology  
 The best manufacturing option for Industry 4.0**





**It is measured by a dial gauge  $\leq 0.002\text{mm}$ ,  
 Test bar 300mm  $\leq 0.005\text{mm}$**



**TIMTOS** 2019/3/4-9  
 27<sup>th</sup> Taipei Int'l Machine Tool Show  
**Booth No. Q0502**

**POSA MACHINERY CO., LTD.**  
 TEL: 886-4-2213-5988 Email: posa.posa@msa.hinet.net



spindleposa





## Exhibit Highlights

### HI-TECH Band Saw E-830

HI-TECH Band Saw E-830 comprehensively meets the requirements of "speed, economical, accuracy", and takes band saws into a new cutting territory. The remarkable feature of the saw offers good cutting performances and absolute reliability. The saw is designed with high rigid double column guide that could achieve higher cutting rate with less vibration and stringer capacity in cutting hard material. It is suitable for using carbide tip saw blade. The guide arm and material feeding move on linear guides way is extremely precise. It is set with HMI for cutting data input and self-diagnosis system, making the operation easy and quick. Furthermore, E-830 has the feature of auto trim cut and back gauge function for remnant cut.

In recent years, band saw machine continues to develop along with the goal of Industry 4.0. E-830 therefore provides the in-house software - I TECH system. I-Tech contains the function of big Data database and machine network, which is available to access internal database to collect sawing data after uploading to the customer service system on the machine. Pre-diagnosis includes machine warning system, motor failure diagnosis, blade utilization analysis,



supplying the users with more direct understanding on the status of the machine. The latest introduction is the QR CODE management system, with QR CODE, managers can more accurately grasp the machining records. QR CODE management incorporates the information and actual recording of operators and workpiece data. It substantially increase management and efficiency.

**EVERISING Machine Co., Ltd.**

Tel: +886-4-2350-5300

Fax: +886-4-2350-5420

E-mail: [evrs@everising.com.tw](mailto:evrs@everising.com.tw)

Website: [www.everising.com](http://www.everising.com)

**Booth No.: I0408**

### Rotary Spindle

Features:

1. Super-precise and high rigidity bearing to overcome axial loads, radial load

and tilting moment.

2. Equipped with super-precise optical encoder to reach high rotary accuracy and repeatability.

3. Backlash is adjustable.

4. Line through rotary center(B-axis), simple and beautiful.

5. Suitable for various controller and servo motor according to customer's requirement.

Applications:

1. 5-axis machining center.

2. Automobile engine, transmission, aerospace and other complex parts machining.

**MicroLab Precision Technology Co., Ltd.**

Tel: +886-4-2239-2345

Fax: +886-4-2239-2357

E-mail: [microlab@twspindle.com](mailto:microlab@twspindle.com)

Website: [www.twspindle.com.tw](http://www.twspindle.com.tw)

**Booth No.: Nangang Hall 2, Q1212**



### TPRK\_HSIC Series Frequency Converter Immersible Pump

The TPRK Series is vertical multistage centrifugal pump, designed for industrial use, especially for machine tools, to carry fluids such as water, coolant, light oil and other clean, non-aggressive matters.



- Industrial circulation system

- Washing/cleaning system

- Filtration system

Immersible vertical multistage centrifugal pump, self-priming, coupling connection between pump and motor, stainless steel construction design ensures corrosion-free operation. The mechanical seal is one-piece type for easy maintenance. Pump increase the pressure by inverter control and can be adjusted according to customer's requirement.

**WALRUS Pump Co., Ltd.**

Tel: +886-2-2636-1123~7

Fax: +886-2-2636-3628

E-mail: [walrus.indus@msa.hinet.net](mailto:walrus.indus@msa.hinet.net)

Website: [www.walruspump.com/zh-tw](http://www.walruspump.com/zh-tw)

**Booth No.: S0916**

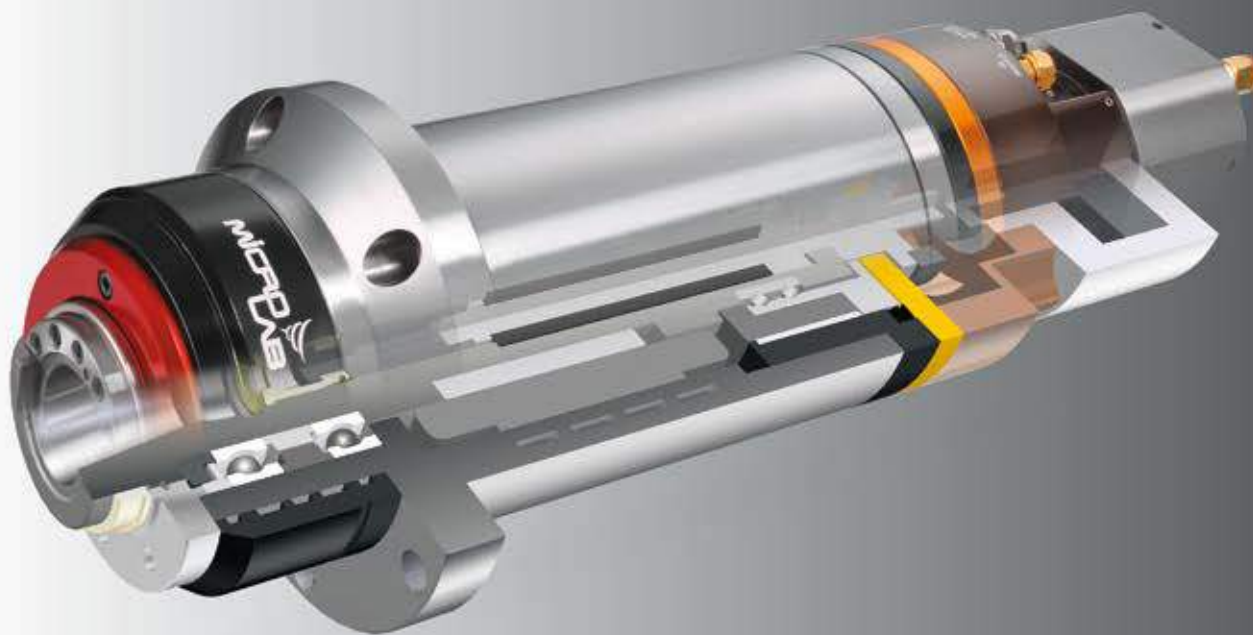

**Integration of High Performance Technology  
Perfect Process Control to  
Ensure Stable Quality**



**TIMTOS**  
第 27 屆台北國際工具機展  
The 27th Taipei Int'l Machine Tool Show

March 4-9, 2019  
TAIPEI NANGANG Exhibition Center, Hall 2  
**SITE: Q1212**

矩將科技有限公司|MicroLab Precision Technology Co.,Ltd|  
Tel:+886-4-22392345 / Fax:+886-4-22392357 / E-mail:microlab@twspindle.com  
台中市40643北屯區松竹路一段530號  
<http://www.twspindle.com>



## Exhibit Highlights

### PP-DM Diamond & PCBN Tool Grinder

PP-DM is specially designed for diamond and PCBN tools. Adopt vitrified diamond grinding wheels. The general grinding wheel is hard to grind diamond and PCBN tools. Also, the tools are expensive, while grinding these tools need to pay more attention. For special angle, PP-DM is attached with CCD and through the monitor, it would be more precise while grinding tool. In addition, the wheel motor with reciprocation system, it is efficient and easy to use.

**PEIPING Precision Enterprise Co., Ltd.**

Tel: +886-4-2358-9088

Fax: +886-4-2358-9098

E-mail: [service@pei-ping.com](mailto:service@pei-ping.com)

Website: [www.pei-ping.com](http://www.pei-ping.com)

Booth No.: N0003



### MARPOSS Machine Protection

Collisions and crashes that occur in machines, equipment or robots can often lead to massive damage with high consequential costs. The repair is expensive, and, above all, production comes to a standstill.



The GEMCMS02 machine protection system from MARPOSS reliably detects collisions and crashes and can stop the relevant drives immediately. The reaction time is less than one milli-second (<1ms). Damage is drastically reduced or even prevented by using our system.

Benefits :

- Surface strain sensor for a simple installation and retrofitting
- Detection of collisions using very slow (quasi static), as well as very fast feeds.

- Minimizes damages
- Extends machine life
- Reduces maintenance costs
- Records the alarm data for further evaluation and analysis

The GEMCMS02 system was developed for stand-alone use and can be easily integrated into the ARTIS GENIOR MODULAR tool and process monitoring system.

**Marposs Company Limited**

Tel: +886-4-2262-2340

Fax: +886-4-2262-2402

E-mail: [sales@tw.marposs.com](mailto:sales@tw.marposs.com)

Website: [www.marposs.com](http://www.marposs.com)

Booth No.: P0320

### TOMAC Rotary Shear System-T5RS1600W

TOMAC cut-to-length and slitting finishing lines offer solutions with the most advancing European technical solutions. We process a wide range of different materials, and sheet metals -including stainless steel, aluminum, hot rolled, cold rolled and surface treated coil. Thanks to our world leading control system, we provide energy regeneration to feedback to our other

components within the finishing line.

We use multi-servo control axis to ensure the finishing line is controlled in synchronization. Our cut to length finishing lines has solutions from stop-cut, flying shear to rotary shear application. Our slitting lines provide solution with double slitter head to ensure high productivity.

With our innovative R&D team in both mechanical and electrical control system, we ensure our customers not only on the mechanical design solutions, but also on mechatronics system solutions for different applications.

**Toptran Machinery Co., Ltd.**

Tel: +886-3-359-5628

Fax: +886-3-359-5629

E-mail: [salestech@toptran.com.tw](mailto:salestech@toptran.com.tw)

Website: [www.toptran.com.tw](http://www.toptran.com.tw)

Booth No.: D-0212



自1961年我們就在全球持續突破與創新，提供你全方位棒材加工

We deliver the innovation worldwide since 1961 in order to provide you the full range of bar-working



**Elite ZERO/112 / 220**

Ø 0.3 / Ø 0.8-12.7 / Ø 2-20

1.8M/3.2M/3.7M



**Steady 326**

Ø 3-26

3.2M



**Boss 542 / 551**

Ø 5-42 / Ø 5-51

2.5M/3.2M/3.7M/4.4M



**Master Series**

Ø 8-80 / Ø 30-100

2.1M/3.3M/3.8M/4.3M

中義科技機械(股)公司 GIULIANI IEMCA MACHINERY CO., LTD. Tel. 886-4-24066970

**TIMTOS** Booth No. N0519  
Nangang Exhibition Hall 1  
We welcome your visit sincerely



# 70<sup>th</sup> ANNI WERSARY



**TIMTOS**  
27th Taipei Int'l Machine Tool Show

stand/

**10626**

**04 - 09, Mar. 2019**



“遠東機械集團—發得科技工業(股)”  
(Tel)+886 5 213 3166/(Fax)+886 5 220 5293  
62154嘉義縣民雄鄉福樂村中山路26號  
<http://www.FATEK.com.tw>





DEFINE FUTURE

品質成就信任，智能定義未來



製造智慧科技·彈指之間  
遠東E智慧服務系統

**FEMTEC** 遠東機械集團  
**GROUP**



**Go Taipei Must Eats · Must Buys · Must Visits**

**Local Food Delicacies**

What would you like to eat today? In Taipei, whether hankering for a Taiwanese-style home-cooked meal, rich with old-time tastes bursting with nostalgia, or for a feast of Cantonese, Jiangzhe, Japanese, European continental, American, or Southeast Asian tastes, rich and varied culinary adventures showcasing different cultural traditions are found everywhere. Exciting minds and palates even further are local ventures in innovative cuisine, conquering diners' picky taste buds. The passion and dedication of the culinary professionals adds a touch of warmth to each dish.



**Cantonese Style Crispy Roast Duck**



**Seasonal Ingredients**

In the pocket of every foodie is a list of Taipei must-experience food treasures. The taste spectrum is without horizon – salty, sweet, bitter, spicy, you name it. The great flavors and warm service found in every corner of this city have also drawn strong praise from Michelin. In the first-ever Michelin Guide Taipei, 2018 published, the Cantonese restaurant Le Palais has garnered Michelin's coveted 3-star glory, the Chinese restaurant The Guest House and Japanese restaurant RyuGin have received 2-star honors, and 17 other restaurants have been bestowed 1-star laurels. Among these are Golden Formosa and Ming Fu, serving authentic Taiwanese fare, providers of Cantonese delicacies Ya Ge, Three Coins, and RAW – the last a place of incessant innovation – along with creators of French, European Contemporary, Japanese, and other culinary specialties.

There is also a list of 36 recommended "Bib Gourmand Restaurants," which includes 10 purveyors of night-market snacks, 5 Taiwanese restaurants, 8 beef-noodle eateries, and dining spots for Jiangzhe, Shanghai, Cantonese, Pekingese, and many international cuisines, providing great new choices each day for both locals and tourists to try.



**Beef Noodles**



**Xiao Long Bao**



**Hand Made Noodles with Chili Sauce**

**Seasonal Events & Activities**

Taipei takes on a wholly new and unique character and atmosphere in each of the four seasons, and the new schedule of events/activities each season fills the city with energy and charm.

Taipei spring days are filled with floating flower petals everywhere you go. The cherry-tree bloom is the headline act of Yangmingshan Flower Festival. The brilliant vignettes of Taipei Azalea Festival bring touches of serenity to bustling neighborhoods. The visual purity and pastoral beauty of the Zhuzihu Calla Lily Festival make the worries of daily life float away.



**Taipei Azalea Festival**

As time rolls into the warm summer, the people of Taipei shift their center of recreational gravity to the riverside parks, visiting Sounds from the River festival concerts, Taipei Riverside Kids Festival, Taipei Water Festival, and Taipei Dragon Boat Festival. These have become favorite family-together extravaganzas, drawing kids young through old.



**Lunar New Year Festival**



**Taipei Water Festival**



**New Year's Eve Countdown Party**

In the autumn, the Guandu and Beitou areas burst with activity. The Taipei International Birdwatching Fair and Beitou Ecological Museum Park provide wonderful get-intimate-with-nature opportunities. Fun Guandu and Hot Spring Season of Taipei incorporate the lives of local citizens. The Guandu International Nature Art Festival and Nuit Blanche Taipei are beloved by aesthetes. And among the many big wintertime happenings are the Taipei Marathon, Christmas Festival, New Year's Eve Countdown Party, Lunar New Year Festival, and Taipei Lantern Festival, igniting the city's passions and warm vitality and infusing the year's ending with great color.

*Text Source: Department of Information and Tourism, Taipei City Government*



經典的工藝 · 精銳的演出

# CHENG CHANG MACHINERY

HIGH PRECISION | LOW INERTIA | HIGH RESPONSIVITY



### SVM系列 (IP54)感應伺服器馬達

Compact Asynchronous motors Quick positioning. High torque moment.

**產品特性**

定位快速、精準、瞬間扭力大、低慣量設計、反應靈敏，高精度製程設計，符合您精密機械的需求。

**應用**

工具機主軸、印刷機械、塑膠射出成形機、分條/複捲機械、包裝機械、紡織機械、一般產業機械。



### DD馬達 第四、五軸機構 · 內藏式主軸定轉子

Rotor&Stator(ER16,ER20,ISO250,BT30,BT40,P.C.B...等) / (100NT-M,200NT-M...等)

**產品特性**

定轉子特性媲美進口產品，規格參數齊全，適合各廠牌驅動器，控制器、規格產品齊全，亦可訂製。

**應用**

內藏式主軸、DD馬達。



---

### SVMA系列 (IP23)感應伺服器馬達

(IP23)Compact Asynchronous motors Quick positioning. High torque moment.Efficient cooling

**產品特性**

定位快速、精準、瞬間扭力大、低慣量設計、反應靈敏，高效率冷卻設計，抗干擾線圈，高精度製程設計，符合您精密機械的需求。

**應用**

工具機主軸、印刷機械、塑膠射出成形機、壓鑄機、分條/複捲機械、包裝機械、紡織機械、沖床(延伸膜)、一般產業機械。



### LINEAR MOTOR 線性馬達

The ironcore design for the higher efficiency of linear motor, and the higher speed and positioning accuracy than ball screw.

**產品特性**

有鐵心設計提高線性馬達效率。高效率的冷卻系統及較高的佔樞率大大提高線性馬達的功率體積比。

**應用**

P,C,B鑽孔機、工具機、產業機械。



---

### SPMA系列 同步伺服器馬達

Compact Synchronous motors Good speed control & torque control.

**產品特性**

高精度、低慣量設計、反應靈敏，速度控制、位置控制、轉矩控制、特性優越符合您精密機械的需求。

**應用**

工具機主軸、印刷機械、塑膠射出成形機、分條/複捲機械、包裝機械、紡織機械、一般產業機械。



### DDM系列 直驅伺服器馬達

Suits injection molders, die-casting machines, machine tools, escalators, elevators, printers and industrial machines that require low speed, high-torque drive.

**產品特性**

取代減速機構，節約設備成本，噪音低、效率高、低速高扭力，提高控制精度，提升產品品質。

**應用**

注塑機攪料、壓鑄機、工具機、電梯扶梯、印刷機械、一般產業機械、低速高扭力的應用。



**晟昌機電股份有限公司** CHENG CHANG MACHINE ELECTRONIC CORP.

43641 台灣台中市清水區和陸路一段1005巷89號 | TEL : 886-4-26202888 | FAX : 886-4-26202777  
No.89, Ln. 1005, Sec. 1, Hemu Rd., Qingshui Dist., Taichung City 43641, Taiwan (R.O.C.)

**廈門晟勝數控設備有限公司** XIAMEN CHENGSHENG NC EQUIPMENT CO., LTD.

廈門同安區金富路100號B棟3樓東側郵編361100 | TEL : 86-592-7191900 | FAX : 86-592-7191961  
No.100, B Building 3rd Floor East Side, Jin-Fu Road, Tong-An District, Xiamen City, 361100



Solpower@solpower.com.tw  
Solpower@msa.hinet.net





參觀總人數: 5,908  
國外: 2,523 國內: 3,385

Scan QR-Code and View more on APP and Wechat



TIMTOS APP



Wechat

# 2019年台北國際工具機展盛大開幕 參展創歷史新高，躍升全球第三大工具機展

以「工業4.0與智慧機械」為主軸的2019年台北國際工具機展 (TIMTOS)，三月四日上午，在南港展覽館2館，舉行盛大開幕儀式。由於是南港展覽館2館正式啟用，此次展覽由全球第五大躍升為第三大工具機展，展出廠商高達1230家，有二十多個國家參展，使用七千個攤位，創下歷史新高，吸引24家國際媒體前來共襄盛舉，盛況空前。

由中華民國對外貿易發展協會 (TAITRA) 及臺灣機械工業同業公會 (TAMI) 聯合主辦的第27屆台北國際工具機展，從三月四日起至九日，在台北世貿一館及三館、臺北南港展覽館一館及2館舉行。出席開幕式的貴賓有總統蔡英文、立法院長蘇嘉全、經濟部政務次長曾文生、國際展覽暨活動協會執行長杜布瓦 (IAEE CEO David DuBois) 等嘉賓，及許多海內外的重量級工具機廠商等冠蓋雲集，把開幕會場擠得水洩不通！

蔡英文總統肯定南港2館的啟用為會展產業創造新的動能及產值，工具機產業在業者的創新求變及政府推動五加二創新產業政策的協助下，持續走向智慧自動化生產，未來政府將持續投入資源協助中小企業加速數位化，提升國際競爭力。

## 南港2館落成 TIMTOS第一個於該館舉辦之大型國際展覽

外貿協會董事長黃志芳在致詞時指出，今年TIMTOS是第一使用南港2館的大型國際展覽，南港2館與1館，加上世貿一館及三館，可以容納更多參

展廠商，提供更完善的參展條件，使得TIMTOS規模擴大，創下此次展覽與臺灣會展的新高，成為全球第三大工具機展，有助於吸引優質買主前來。

南港2館是全臺首座獲得「黃金級綠建築標章」的專業展覽館，今天正式啟用，是臺灣經濟與會展產業的重要里程碑。未來南港雙館~南港1館及2館，將會是臺灣規模最大的國家級會展中心，也是國際會展產業在臺灣辦理重大產業活動的最佳選擇。

黃志芳董事長指出，臺灣的面積雖小，但是我們培育了許多堅強的產業，可以與世界頂尖相媲美，例如臺灣工具機產業，長期以來與全球工業大國競爭，毫不遜色。而我們的天然資源，雖比起德國、義大利、日本等國要少，要如何和全球競爭？雖然我們的天然資源有限，但是人的潛能無限，我們的心智與力量卻很強大。

這次TIMTOS聚集工具機產業最出類拔萃的企業，充分展現了創造力與創新能量；同時臺灣是智慧製造王國，此次展覽亦是展現一個小島國家，以工程技術與聰明才智，迎接全球挑戰的契機。

## 期許臺灣成為全球的「智慧機械製造王國」

機械公會理事長柯拔希指出，今年辦理的工具機研究發展創新產品競賽，特別增加智慧機械獎項，以厚植產業實力，鼓勵廠商研發創新。本屆共受理43件參賽作品，聘請國內外知名工具機設計與製造專家擔任評審，競爭非常激烈。

TIMTOS不只是全球參展廠商展

現實力的舞臺，也是延攬產業優秀人才進入機械業的最佳平臺。柯理事長說，為了讓大專院校師生擁有國際觀，到展場觀摩學習，更甚於學校的教學，而今年報名參觀展覽的學生團體，非常踴躍，共有53所學校，超過7,200學生組團前來觀摩學習，總人數較上屆倍數成長。

統計顯示，臺灣機械產業持續成長，2017年臺灣機械業的產值，突破新台幣兆元，達到1.1兆元；去年2018年機械業出口值274億美元，成長7.2%；而生產值增加約800億元，達到1.18兆元，成長約7.3%，續創歷史新高。而工具機產業的出口值36.6億美元，較去年成長9.5%。

機械公會去年八月發表智慧機械產業白皮書，規劃未來持續朝向智慧機械與智慧製造的方向邁進，期許臺灣成為全球的「智慧機械製造王國」。

今年機械公會將扮演催生和推動角色，力推智慧機械上雲端，用共享經濟的概念，建立機械雲端服務平臺的軟硬體系統與示範運行服務團隊，並協助設備業者，導入機械雲服務。發展智慧機械與智慧製造所創造的高附加價值，預計將可實現2025年機械業產值達到2兆臺幣的願景。

柯拔希理事長表示，預估今年上半年因美中貿易戰等變數，先保守看待，但是下半年表現，有機會優於上半年，今年景氣可維持先蹲後跳的格局。估計這次會展的潛在訂單，可望達到20億美元，全年產業成長幅度大約10%。

柯理事長期望，政府能夠協助機械業上市櫃，增列機械類股，協助機械業在金融市場募資，希望三年內機械設備

業上市櫃，達到五十家以上規模。

## 政府與民間團體攜手合作 共創雙贏未來

經濟部政務次長曾文生則表示，這次南港2館的落成與國際工具機展開幕，是雙喜臨門，感謝機械業者各公協會，扮演積極推動政策協商角色，讓廠商的意見傳達更有效率。

國際展覽暨活動協會執行長杜布瓦(David DuBois)致詞時指出，臺灣展場的硬體建設，在朝野共同合作努力下，尤其是總統蔡英文的支持下，今天成功推出了全新的南港2館，將更能把臺灣推向全世界舞台，讓全世界都知道臺灣有舉辦大型國際展會的實力與場地，對於臺灣推動展會活動不遺餘力甚表推崇。

上午的開幕式，並邀請貴賓剪綵後，共同合影留念，留下珍貴歷史鏡頭，隨後在南港館2館舉行雞尾酒會。

## 五日起舉辦多場高峰論壇，共有四大主題

本屆展覽聚焦工業4.0、智慧製造及AI技術，從研發到整合產業鏈，從單機到完整解決方案，TIMTOS可以協助業者，找尋優化生產的最佳利器與服務。除豐富多元的展覽外，本屆特色之一，就是自三月五日起，在世貿台北國際會議中心101會議室，舉辦多場高峰論壇，共有四大主題：分別是智慧聯網、積層製造、航太智慧製造、汽車製造業變革，邀請到世界領先的巨擘，分享產業現況及未來，是業者不可錯過的良機。■



## 聚焦智慧製造，促進機械工業整體轉型

3月4日，2019年台北國際工具機展覽會 (TIMTOS 2019) 記者會在南港展覽1館順利召開。中華民國對外貿易發展協會黃漢唐處長、臺灣機械工業同業公會工具機專業委員會陳燦輝會長、臺灣機械工業同業公會機械零組件專業委員會許文憲會長、臺灣機械工業同業公會金屬成型機械專業委員會蕭文龍會長、臺灣機械工業同業公會王正青秘書長，以及來自全球的媒體記者出席了此次記者會。

通過各位演講嘉賓的致詞以及現場的問答交流，與會人士對臺灣的工具機、零組件、自動化等產業的發展現狀有了更全面的瞭解，也感受到了臺灣製造業智慧轉型的迫切需求，以及當局致力於依靠物聯網、VR虛擬實境技術、人工智慧、大數據等前沿技術，提高產品附加價值、促進全產業鏈自動化、智慧化的決心。

在會上，黃漢唐處長首先分享了TIMTOS 2019年的亮點和特色。黃處長指出，此次南港2館正式啟用，展覽面積進一步擴大，共有7000個攤位和1230家參展商參展。他強調此次展會的主題為“工業4.0、智慧製造”，機器人、感測器、物聯網技術、雲端運算、

大數據分析，這些數位化的解決方案能協助傳統製造企業，建立柔性化、智慧化、高效的生產線，從而使工業4.0能夠更加適合客制化、小批量的客戶需求。AI技術和協作機器人也是此次展出的亮點，通過將人工智慧與製造系統進行融合，人機協作成為可能。這種新型的協作方式，可以進一步減少人工錯誤，提高生產精度和表面品質，從而有助於實現更安全、高效的生產。最後，黃處長指出，為了促進供需雙方的進一步交流，TAITRA已邀請了來自90個國家的7,500位買主來現場參會，其中有來自德國、美國、加拿大、荷蘭、義大利、墨西哥等14個國家的20家採購團將會參與“一對一”的採購洽談會。

陳燦輝會長指出，近幾年臺灣的工具機產業在開拓海外市場方面已取得不俗的成績。2018年，在各方努力下，臺灣工具機產業的總出口額達到了36.6億美元，同比增長了9.5%。由於中美貿易的影響和國際市場需求的變化，2019年對臺灣的工具機產業而言，可能會帶來更多的挑戰。對此，陳會長建議各企業應及時調整佈局，積極開拓越南、印尼等市場。同時，陳會長也透露，政府為了推動機械智慧化的進程，已將智慧機



(从左至右) 臺灣機械工業同業公會王正青秘書長、臺灣機械工業同業公會機械零組件專業委員會許文憲會長、臺灣機械工業同業公會工具機專業委員會陳燦輝會長、中華民國對外貿易發展協會黃漢唐處長、臺灣機械工業同業公會金屬成型機械專業委員會蕭文龍會長

械納入“5+2”的創新產業規劃中，力求保持北、中、南部的平衡發展，同時通過吸引海外人才、開拓國際市場等舉措，努力同國際趨勢進行銜接。

此外，臺灣機械工業同業公會機械零組件專業委員會許文憲會長、臺灣機械工業同業公會金屬成型機械專業委員會蕭文龍會長也分別發表了演說。許文憲會長指出，臺灣的零組件產業已成功打入歐美、日本等高端市場，已在高附加價值的產品供應鏈上佔有一席之地。

未來，臺灣的零組件企業需要加強自動化、智慧化轉型，依靠科技，打造智慧化解決方案，以更好地應對市場需求。蕭文龍會長指出，2019年中國大陸的市場仍值得期待，印度、越南、土耳其、美國這些國家也將會為自動化設備帶來大量商機。臺灣金屬成型機械企業應該複製在大陸智慧化生產的成功經驗，此外，還應充分利用VR虛擬實境技術，進行遠端的設備展示，從而為開拓更廣的市場助力。■

# HEIDENHAIN

**PARTNER AUTOMATION**

即刻擁有高超的自動化夥伴  
來幫您實現自動化的生產

- 專業的客戶服務
- 快速的建置
- 投資安全性高



## 客製您的自動化解決方案



想了解更多自動化解決方案，請掃描QR Code：  
[www.heidenhain.de/automation-partners](http://www.heidenhain.de/automation-partners)

TIMTOS™

攤位號碼：南港二館 Q0124  
2019年3月4~9日

# HEIDENHAIN

海德漢股份有限公司

台中市40768台中工業區33路29號

☎ (04)2358-8977

FAX (04)2358-8978

E-Mail: info@heidenhain.tw

[www.heidenhain.tw](http://www.heidenhain.tw)



## 國際買主看展還血拚 洽談臺廠採購最新機

**臺**灣工具機在國際市場的競爭力，從一場採購洽談會可見一斑。這些來自世界各地的買主都說，因為臺灣的工具機真的非常好用，而且在他們的當地市場很受歡迎，所以他們會一來再來，一買再買。臺灣的高品質工具機，對這些愛用者來說，幾乎就像是印鈔機。

台北國際工具機展昨(4)日在台北南港展覽館2館盛大揭幕，隨後在1館5樓，即由國際買主與臺灣廠商展開採購洽談，總共有16個國家的22位買主，在昨天的這項洽談會與臺灣廠商討論採購事宜。

多位買主表示，他們到臺灣來買工具機已經不是第一次。南非的提摩西·吉伯特(Timothy Gilbert)說，他已經是第5次來看TIMTOS，前前後後已經到臺灣來看工具機超過10年，每年都來買。烏克蘭的瑟希·費登科(Serhii Fedenko)也是最近十幾年每次都來看TIMTOS，經常到臺灣採購。印度的羅希·雷依(Rohit Rai)更是驕傲地說，他是來臺灣買工具機的常客，過去25年來，除了每次的TIMTOS一定不缺席外，他也跟前兩位一樣，「每年」都會來臺灣買工具機。

這些經常到臺灣來買工具機的外國大買主都說，因為臺灣的工具機製造廠一直把品質做得很好，價格在國際市場又非常具有競爭力，對他們來說，臺灣是他們買工具機的首選。而且他們來臺灣買的機種包羅萬象，從車床、磨床、鑽床到大型智慧機台什麼機型都可能買。

至於為什麼每年都來臺灣，還一定要來看TIMTOS？印度的雷依說，因為他們看到，臺灣的工具機技術和功能年年都在進步，所以他除了例行的每年採購，也一定會來看TIMTOS。因為臺灣的工具機廠，會在TIMTOS上，展示他們採用最新科技生產，具備最強功能的新機種。

台北國際工具機展採購洽談會，是由各地駐外單位外貿人員邀請，推薦當地優質廠商到外貿協會的線上平臺登錄，然後由臺灣廠商上線報名表示有興趣與其中的國外買主洽談，再由國外買主確認同意接受洽談，最後確定在TIMTOS的採購洽談會上見面，雙方當面磋商進一步的採購事宜。

主辦單位表示，今年TIMTOS採購洽談會非常圓滿成功，22家外國買主都和臺灣的廠商見面洽談。由於他們不遠千里到臺灣來談，洽談成果樂觀可期。■



### 超強動力 來自完美結構

GT新虎將 專業三軸·五軸高速機



**GT-1612V**  
門型高速加工中心機  
High Speed Double Column Machining Center



**GT-SP45 Linear**  
門型超精密線馬型加工中心機  
Ultra High Precision Double Column Machining Center with Linear Motor Drive



**GT-ML800**  
五軸銑車複合機  
5 axis Mill-Turn Machining Center



**GT-H2517F**  
天車式五軸高速加工中心機  
Gantry type 5 axis High Speed Machining Center

歡迎蒞臨  
台北國際工具機展  
**TIMTOS** 2019/3/4-9  
Taipei Intl. Machine Tool Show  
南港一館 **J0410**

**新虎將機械工業股份有限公司**  
GENTIGER MACHINERY INDUSTRIAL CO., LTD.  
www.gentiger.com.tw E-mail: GT@gentiger.com.tw  
Tel: +886-4-2683 6919 Fax: +886-4-2683 9900

**精密銑床、CNC 高速機領導品牌**

#### 「2019台北國際工具機展」接駁車資訊

本展覽地點為南港展覽館1館、2館及世貿1、3館，主辦單位提供之免費接駁車資訊如下：

路線	行駛時間/上車地點/車輛數
	3/4-8 : 10:00-18:00
世貿一館 ↔ 南港展覽館	3/9 : 10:00-15:30
1 & 2 館 (對開)	一館:市府路 南港1館: 正門 南港2館: 經貿二路62巷



「2019年台北國際工具機展」研討會/活動日程表

日期	時間	活動內容 / 講題	主 / 協辦單位	地點	備註	
3月4日 (星期一)	10:30	開幕典禮	外貿協會·機械公會	南港展覽館 2 館 4 樓門廳	憑邀請函入場 簡韻茗小姐 +886-2-27255200#2867	
	8:00-17:00	Bfuture 全球新品發布會	慶鴻機電工業股份有限公司	南港展覽館 1 館 402c 會議室	林盈函小姐 +886-4-23509188#527	
	8:00-17:00	發格控制器及光學尺產品介紹	發格自動化股份有限公司	南港展覽館 2 館 602 會議室	溫恕民先生 +886-4-23851558	
	13:30-16:30	2019 台北國際工具機展採購洽談會	外貿協會	南港展覽館 1 館 504 會議室	柯采慧小姐 +886-2-27255200#1573	
	14:00-15:00	2019 台北國際工具機展記者會	外貿協會·機械公會	南港展覽館 1 館 403 會議室	侯馨青小姐 +886-2-23494677	
	16:00-17:30	馬來西亞機械市場說明會暨 TAITRA 及 PENFEIA 合作備忘錄簽約典禮	外貿協會	南港展覽館 1 館 404 會議室	陳冠儒小姐 +886-2-27255200#2693	
3月5日 (星期二)	8:00-17:00	Bfuture 全球新品發布會	慶鴻機電工業股份有限公司	南港展覽館 1 館 402c 會議室	林盈函小姐 +886-4-23509188#527	
	8:00-17:00	發格控制器及光學尺產品介紹	發格自動化股份有限公司	南港展覽館 2 館 602 會議室	溫恕民先生 +886-4-23851558	
	8:30-12:00	工具機關鍵模組暨智慧製造應用技術發表	工研院智慧機械科技中心	南港展覽館 1 館 505a 會議室	張惠怡小姐 +886-49-2345309	
	9:00-12:00	台日機械企業經貿交流會	機械公會	南港展覽館 1 館 504bc 會議室	王篠傑先生 +886-2-23494668	
	9:00-16:00	TIMTOS 2019 高峰論壇	經濟部國際貿易局	台北國際會議中心 101 會議室	高麗茹小姐 +886-2-27255200#2679	
	16:00-17:00	德國工藝 享譽國際 - 德國工具機產業發展新趨勢	外貿協會德經處	台北國際會議中心 101 會議室	鄭芳姿小姐 +886-2-7735-7524	
	10:00-12:00	《工具機組裝新利器 -Renishaw 全新 XK10 校準雷射系統》新品發表會	雷尼紹股份有限公司	南港展覽館 1 館 402a 會議室	莊詠偉先生 +886-4-24603799	
	10:30-12:00	TNC 640 高效率五軸輪廓控制器 - 高可靠度創新加工技術的優勢	海德漢股份有限公司	南港展覽館 1 館 403 會議室	蔡語耕小姐 +886-4-2358-8977 #1035	
	13:00-15:00	NIDEC-Commander C 產品發表會	睿欣實業股份有限公司	世貿一館 第 4 會議室	陳曦小姐 +886-4-22606502	
	13:00-15:00	工業 4.0 智慧製造研討會 / 模具智能化生產單元	徠通科技股份有限公司	南港展覽館 1 館 402ab 會議室	張詠晴小姐 +886-4-23599688#226	
	15:30-18:00	徠通科技全球代理商會議	徠通科技股份有限公司	南港展覽館 1 館 402ab 會議室	張詠晴小姐 +886-4-23599688#226	
	14:00-15:00	2020 年日本國際工具機展覽會 JIMTOF 記者會	日本工作機械工業會	南港展覽館 1 館 404 會議室	+81-3-34343961	
	14:30-16:30	智慧製造聯網數據增值產業聯盟會員大會	財團法人工業技術研究院 ITRI	南港展覽館 1 館 504a 會議室	陳玉雲小姐 +886-3-5916720	
	15:00-16:00	臺灣機械工業同業公會與馬來西亞檳城機器廠商會簽訂合作協議	機械公會	南港展覽館 1 館 4 樓貴賓簡報室	林子鈞先生 +886-2-23494694	
	15:00-17:30	台灣麗馳全球代理商大會暨新產品發表會	台灣麗馳科技股份有限公司	南港展覽館 1 館 401 會議室	莫金燕小姐 +886-4-26815711#246	
	18:30	2019 年台北國際工具機展歡迎酒會暨工具機研究發展創新產品競賽頒獎典禮	工具機發展基金會·外貿協會·機械公會	南港展覽館 1 館 3 樓燴館宴會廳	蔡宜真小姐 +886-2-23110358	
	3月6日 (星期三)	8:00-17:00	Bfuture 全球新品發布會	慶鴻機電工業股份有限公司	南港展覽館 1 館 402c 會議室	林盈函小姐 +886-4-23509188#527
		8:00-17:00	「2019 年台北國際工具機展」高中職、大專、大學、研究所導覽活動	機械公會	南港展覽館 1 館 500 會議室	黃雅華小姐 +886-2-23494672
8:00-17:00		發格控制器及光學尺產品介紹	發格自動化股份有限公司	南港展覽館 2 館 602 會議室	溫恕民先生 +886-4-23851558	
9:00-16:00		TIMTOS 2019 高峰論壇	經濟部國際貿易局	台北國際會議中心 101 會議室	高麗茹小姐 +886-2-27255200#2679	
16:00-17:00		德國工藝 享譽國際 - 德國工具機產業發展新趨勢	外貿協會德經處	台北國際會議中心 101 會議室	鄭芳姿小姐 +886-2-7735-7524	
8:00-17:00		工業 4.0 與智慧機械技術應用趨勢研討會	台灣易格斯有限公司 遠播資訊股份有限公司	南港展覽館 1 館 505 會議室	孫桂芬小姐 +886-2-25855526#225	
9:00-11:00		永進機械代理商會議	永進機械工業股份有限公司	南港展覽館 1 館 401 會議室	陳家欣小姐 +886-4-25623211#1812	
10:30-12:00		選擇美國投資研討會 - 錢進美國教戰守則	美國在台協會商務組 臺灣機械工業同業公會	南港展覽館 1 館 501 會議室	+886-2-27201550#334	
13:00-17:00		新產品說明會	喬崑進科技股份有限公司	南港展覽館 1 館 502 會議室	黃悖密小姐 +886-4-22712000#231	
13:00-17:00		程泰集團年度產品發表會	程泰集團	南港展覽館 1 館 504a 會議室	江苡璉小姐 +886-4-24629698#62107	
13:30-16:30		礦物複合材料 (人造花崗石) 在機械領域的應用	山東納諾新材料科技有限公司	南港展覽館 1 館 404 會議室	崔美麗小姐 +86-531-88917773	
13:30-17:00		中國砂輪新產品發表會	中國砂輪企業股份有限公司	世貿一館 第 2 會議室	王文仁先生 +886-2-26791931#3309	
8:00-17:00		直得科技新品說明會	直得科技股份有限公司	南港展覽館 1 館 3 樓福軒	李家慶先生 +886-6-5055858#162	
8:00-17:00		Bfuture 全球新品發布會	慶鴻機電工業股份有限公司	南港展覽館 1 館 402c 會議室	林盈函小姐 +886-4-23509188#527	
8:00-17:00		「2019 年台北國際工具機展」高中職、大專、大學、研究所導覽活動	機械公會	南港展覽館 1 館 500 會議室	黃雅華小姐 +886-2-23494672	
8:00-17:00		發格控制器及光學尺產品介紹	發格自動化股份有限公司	南港展覽館 2 館 602 會議室	溫恕民先生 +886-4-23851558	
13:30-17:00		2019 台北國際工具機展 GLORIA 智慧製造創新應用論壇	科技部·外貿協會·機械公會	南港展覽館 1 館 402ab 會議室	郭瑀璇小姐 886-2-25774249#827	
14:00-16:00		液壓系統節能技術與切削冷卻液之過濾處理	台灣賀德克技術有限公司 得霖企業有限公司	南港展覽館 1 館 502 會議室	楊雅淑小姐 +886-4-22602278	
14:00-16:00	研磨加工品質、效率的確保與提升	忠達貿易有限公司	南港展覽館 1 館 505b 會議室	張怡婷小姐 +886-2-29115226#607		
3月7日 (星期四)	8:00-17:00	直得科技新品說明會	直得科技股份有限公司	南港展覽館 1 館 3 樓福軒	李家慶先生 +886-6-5055858#162	
	8:00-17:00	Bfuture 全球新品發布會	慶鴻機電工業股份有限公司	南港展覽館 1 館 402c 會議室	林盈函小姐 +886-4-23509188#527	
	8:00-17:00	「2019 年台北國際工具機展」高中職、大專、大學、研究所導覽活動	機械公會	南港展覽館 1 館 500 會議室	黃雅華小姐 +886-2-23494672	
	8:00-17:00	發格控制器及光學尺產品介紹	發格自動化股份有限公司	南港展覽館 2 館 602 會議室	溫恕民先生 +886-4-23851558	
	13:30-17:00	2019 台北國際工具機展 GLORIA 智慧製造創新應用論壇	科技部·外貿協會·機械公會	南港展覽館 1 館 402ab 會議室	郭瑀璇小姐 +886-2-25774249#827	
	14:00-16:00	液壓系統節能技術與切削冷卻液之過濾處理	台灣賀德克技術有限公司 得霖企業有限公司	南港展覽館 1 館 502 會議室	楊雅淑小姐 886-4-22602278	
	14:00-16:00	研磨加工品質、效率的確保與提升	忠達貿易有限公司	南港展覽館 1 館 505b 會議室	張怡婷小姐 +886-2-29115226#607	
3月8日 (星期五)	8:00-17:00	直得科技新品說明會	直得科技股份有限公司	南港展覽館 1 館 3 樓福軒	李家慶先生 +886-6-5055858#162	
	8:00-17:00	Bfuture 全球新品發布會	慶鴻機電工業股份有限公司	南港展覽館 1 館 402c 會議室	林盈函小姐 +886-4-23509188#527	
	8:00-17:00	「2019 年台北國際工具機展」高中職、大專、大學、研究所導覽活動	機械公會	南港展覽館 1 館 500 會議室	黃雅華小姐 +886-2-23494672	
	8:00-17:00	發格控制器及光學尺產品介紹	發格自動化股份有限公司	南港展覽館 2 館 602 會議室	溫恕民先生 +886-4-23851558	
	9:30-18:00	智慧製造論壇	流線傳媒股份有限公司 外貿協會	世貿一館 第 4、5 會議室	林淑靜小姐 +886-2-87715865#180	
	9:30-14:00	迪普馬移動解決方案產品培訓研討會	迪普馬移動解決方案集團公司 羅昇企業股份有限公司	南港展覽館 1 館 502 會議室	吳容睿小姐 +886-2-29958400#1232	
	10:00-17:00	中興大學與精密機械研究發展中心 智慧機械產學論壇技術成果發表會	國立中興大學 & 財團法人精密機械研究發展中心	南港展覽館 1 館 403 會議室	葉湘琳小姐 +886-4-22858139	
	13:00-16:00	活用 3D 列印與 3D 量測科技，邁入 3D 智能檢測時代	馬路科技顧問股份有限公司	南港展覽館 1 館 404 會議室	林雨潔小姐 +886-2-2999-6788#284	
3月9日 (星期五)	8:00-17:00	「2019 年台北國際工具機展」高中職、大專、大學、研究所導覽活動	機械公會	南港展覽館 1 館 500 會議室	黃雅華小姐 +886-2-23494672	
	8:00-17:00	發格控制器及光學尺產品介紹	發格自動化股份有限公司	南港展覽館 2 館 602 會議室	溫恕民先生 +886-4-23851558	

如有修正，以現場實際狀況為準，不另通知。



## 台北南港展覽館2館TaiNEX 2特色介紹

**台**北南港展覽館2館(Taipei Nangang Exhibition Center, Hall 2，以下簡稱TaiNEX 2)，為南港會展中心擴建計畫項目，由經濟部投資興建、貿協營運管理，於昨日(2019年3月4日)正式啟用，具有全臺獨一無二中花園展覽空間，適合辦理展覽、國際會議、企業會議等各項活動。

TaiNEX 2 由知名德國建築設計公司gmp Architects von Gerkan, Marg and Partners及臺灣潘冀聯合建築師事務所聯手設計，整體結構造型風格，類似古羅馬建築理論：實用、堅固、美觀、外型簡約具穿透感。

台北南港展覽館1館 (Taipei

Nangang Exhibition Center, Hall 1，以下簡稱TaiNEX 1)與TaiNEX 2兩館合計，可提供5,000個攤位與38間分組會議室，滿足大部份國際展覽及年會所需空間，將成為臺灣最耀眼會展產業核心，以及亞洲主要會展中心!

TaiNEX 2特色包括：

1. 為全臺首座榮獲「黃金級綠建築標章」的專業展覽場館。
2. 高大方正宏偉的玻璃外觀建築，搭配水波狀的特色屋頂，與南港1館船桅狀的屋頂相互輝映，已成為台灣會展的新地標。
3. 非常便捷交通，45分鐘可抵桃園國際機場，15分鐘抵達松山機場，5分

鐘抵南港站3鐵共構—台鐵、高鐵、北捷，並有地下連通道連接TaiNEX 1與捷運站。

4. 多樣住宿選擇，從展館搭乘捷運15分鐘即抵達市中心鬧區，大臺北地區共500多間旅館提供25,000間房間入住。
5. 挑高的展覽場，1樓展場挑高12米，4樓挑高9米，全館共提供2,300個展覽攤位。
6. 7樓多功能會議中心為全臺最大無柱會議空間，挑高9米，可容納3,600人及14間分組會議室。
7. 7樓玻璃帷幕，從寬廣室內走道可觀賞室外6,100平方公尺的空中花園

及遠眺台北101。

8. 充足全館停車空間，達1,296個並設有智慧停車系統，地下1樓停車場挑高4米，可供遊覽車及貨車停放。

9. 流暢垂直動線，全館共設有28座電扶梯及16座快速客貨梯。

除此次的台北國際工具機展之外，今年台北國際汽車零配件展、台北國際電腦展、台北國際食品展及台北國際自行車展等大型國際展覽，均將選在TaiNEX雙館展出，TaiNEX 2的啟用將為台灣帶來更多國際級展覽會議活動! ■

**TaiNEX 2新聞資料聯絡：**  
南港國際展覽中心2館 陳瑾緻高專  
02-2725-5200 #6616  
macy@taira.org.tw



## 矩將：朝世界級高性能主軸邁進

矩將科技：

用客戶所需要的切削性能做設計

MICRO-LAB 微研究室，以感測、縮小、專精的研究開發為矩將成立的使命。專於精密機械研發中心，專責工具機性能研發及檢測，深感操控機械性能的靈魂非主軸莫屬，而其精確密度高不可測，一直以來台灣雖為工具機之強，但機台的主軸卻依賴國外進口，這也是矩將於1999年成立的目的，以對機械性能的理解、研究及設計生產適合各種不同功能的專業主軸。

矩將科技有限公司  
電話：+886-4-22392345  
傳真：+886-4-2239235

microlab@twspindle.com  
Website www.twspindle.com  
傳真號碼：Q1212



以專精各式高階主軸聞名工具機業界的矩將，此次驚豔亮相TIMTOS 2019南港2館。

主軸作為工具機械的核心關鍵組件，高階的主軸，一直以來都為國外技術所壟斷。為了實現主軸生產的當地化，矩將除了研發皮帶式主軸、直結式主軸、鑽攻中心機主軸外，長期以來更是以內藏式主軸為核心研發方

向，且近年更推出特殊功能型整合性搖擺頭主軸、Capto車銑兩用主軸、液靜壓磨床主軸與更高扭力、功率的快速切削主軸。

矩將的內藏式主軸均採用多次道嚴密迷宮，同時標配迷宮吹氣，高速運轉時切削油污不會侵入軸承；全系列標配甩水環，於高速切削時，減低切削液濺入迷宮區域；冷卻迴圈通道經嚴密設

計，可有效帶走線圈及軸承熱量，減低溫升熱變形精度誤差；專利設計四瓣爪導環，主軸加減速時，不會有異音及動平衡變化情形；外部一體設計，安裝接合面精度準確，增加機台精度，減少精度調整時間；以多次多平面進行動平衡校正，增加制振機構，提升振動性能。

整合性搖擺頭主軸ISO25、BT30、BT40、HSK40E、HSK63A等一系列產品適用於有B軸設計的五軸加工機，主要都應用於3C電子產業加工，及航太或泛用等加工。另外一款大型內藏式主軸HSK100A，適用於大型龍門機的高速高剛性加工。

針對當下工具機發展的潮流，矩將保持不斷地學習和更新，配合工業4.0及智慧化潮流。目前，在矩將生產的主軸產品中，已經開始感應感測器的植入，方便使用者隨時監控主軸情況。客戶的回饋不斷推動矩將創新的

產生，同時也鞭策我們加強對市場趨勢的感知能力。

矩陣思維，將引創新。主軸賦予機台靈魂，決定機械加工的效能。矩將重視精進的技術能力及Step by Step的規矩，不懈自行研發、創新設計、檢驗測試、精益求精，為客戶無限倍增競爭力。 ■

要知道更多內容，請參觀TIMTOS，  
我們在南港2館Q1212展位，  
或是我們的官網：  
<https://www.twspindle.com.tw/>

### 「2019台北國際工具機展」接駁車資訊

本展覽地點為南港展覽館1館、2館及世貿1、3館，主辦單位提供之免費接駁車資訊如下：

路線	行駛時間/上車地點/車輛數
世貿一館 ↔ 南港展覽館 1 & 2 館 (對開)	3/4-8：10:00-18:00 3/9：10:00-15:30 一館:市府路 南港1館：正門 南港2館：經貿二路62巷



# 2019 年台北國際工具機展 高峰論壇

時間：2019年3月5日(二) 09:00-17:00  
地點：臺北國際會議中心101會議室 (臺北市信義區信義路五段1號)

時間：2019年3月6日(三) 09:00-17:00  
地點：臺北國際會議中心101會議室(臺北市信義區信義路五段1號)

主題一：智慧聯網	
時間	議程/講師
09:00-09:20	來賓報到
09:20-09:30	開場致詞 林芳苗 / 中華民國對外貿易發展協會副秘書長 柯拔希 / 臺灣機械工業同業公會理事長
09:30-10:10	【主題演講】How SAP helps Customers to Create Value with Industry 4.0 and Internet of Things in Discrete Industries Bernhard Meyer / SAP Global Solution Manager, Industry Business Unit, Industrial Machinery & Components (IM&C)
10:10-10:50	【主題演講】智能IoT智能機器管理平台 劉新正 / ITTS東捷資訊服務副總經理
10:50-11:30	【主題演講】從產學實踐台灣工業物聯網應用 覺文郁 / 虎尾科技大學校長
11:30-12:10	【主題演講】工業AI和工業互聯網未來趨勢分析 李傑 / 美國辛辛那提大學教授
12:10-12:30	【主題對談】未來製造工作型態 主持人：莊國欽 / 台灣區機械工業同業公會榮譽理事長 對談貴賓：所有主講人
主題二：積層製造	
時間	議程/講師
13:00-13:30	來賓報到
13:30-14:10	【主題演講】未來製造業的高端加工技術解決方案 Neun Harald / DMG MORI 營運長
14:10-14:50	【主題演講】The Evolution of Metal Additive Manufacturing: Leveraging the Machine Tool Infrastructure Pascal Pierra / Optomec 亞太區總監
14:50-15:20	【主題演講】增材智造實現快速生產 楊奇杰 / 馬路科技大中華區銷售經理
15:20-16:00	【主題對談】洞悉金屬3D列印未來發展 主持人：路怡珍 / 數位時代科技主播
16:00-17:00	德國工藝享譽國際—德國工具機產業發展新趨勢

主題三：航太智慧製造	
時間	議程/講師
09:00-9:20	來賓報到
09:20-10:00	【主題演講】駕馭高動態加工技術的開創性解決方案 Peter Topol / 海德漢資深產品經理
10:00-10:40	【主題演講】實現工業4.0—與西門子共創數位未來 Tino Hildebrand / 臺灣西門子副總經理
10:40-11:20	【主題演講】數位化協作與創新—啟動航太製造的工業復興! Rémi GERMAIN / 達梭系統全球策略聯盟副總裁
11:20-12:00	【主題演講】Advanced manufacturing technologies Cyrille SCHWOB / 空中巴士公司亞太區總監
12:00-12:30	【主題對談】變革中的製造業—預見未來五年 主持人：胡竹生 / 工研院機械與系統研究所所長 對談貴賓：所有主講人
主題四：汽車製造業變革	
時間	議程/講師
13:00-13:30	來賓報到
13:30-14:10	【主題演講】智慧製造全新局面來臨·工業機器人的創新技術及應用 鍾鴻鈞 / ABB區域經理-服務銷售(東南亞及台灣)
14:10-14:50	【主題演講】CNC Systems for Factory of the Future 陳俊隆 / 台灣博士力士樂股份有限公司工廠自動化協理
14:50-15:20	【主題演講】實現工業4.1的智慧工廠自動化 鄭芳田 / 成功大學智慧製造研究中心講座教授兼主任
15:20-16:00	【主題對談】改革正在加速·我們準備好了嗎? 主持人：路怡珍 / 數位時代科技主播 對談貴賓：所有主講人
16:00-17:00	德國工藝享譽國際—德國工具機產業發展新趨勢

\*主辦單位保留議程變更及參加資格審核之權利  
\*現場提供中英文口譯

## 活動嘉賓

**Bernhard Meyer**  
SAP Global Solution Manager, Industry Business Unit, Industrial Machinery & Components (IM&C)



**Neun Harald**  
DMG MORI 營運長



**Peter Topol**  
海德漢資深產品經理



**胡竹生**  
工研院機械與系統研究所所長



**劉新正**  
ITTS東捷資訊服務副總經理



**Pascal Pierra**  
Optomec 亞太區總監



**Tino Hildebrand**  
臺灣西門子副總經理



**鍾鴻鈞**  
ABB區域經理-服務銷售(東南亞及台灣)



**覺文郁**  
虎尾科技大學校長



**楊奇杰**  
馬路科技大中華區銷售經理



**Rémi GERMAIN**  
達梭系統全球策略聯盟副總裁



**陳俊隆**  
博士力士樂股份有限公司工廠自動化協理



**李傑**  
美國辛辛那提大學教授



**路怡珍**  
數位時代科技主播



**Cyrille SCHWOB**  
空中巴士公司亞太區總監



**鄭芳田**  
成功大學智慧製造研究中心主任





# 2019中國大陸工具機產業發展趨勢

**為**了把脈2019年中國大陸市場工具機產業發展趨勢，本文特別匯總了中國機床工具工業協會常務副理事長毛予鋒、中國機械工業聯合會專家委員會副主任蔡惟慈、中國機床總公司總經理梁楓對產業形勢的解讀。

## “總量趨穩，結構升級”

此前，中國機床工具工業協會常務副理事長毛予鋒表示：總體看，工具機消費市場和產業已由2015年之前“需求總量下降，結構快速升級”的運行特徵逐漸轉變為“需求總量趨穩，結構快速升級”。這一新反映出的運行特徵還將持續一段時期。

同時指出，根據中國大陸統計局相關資料進行測算，2018年上半年中國大陸金屬加工工具機產出約為135億美元，同比增長11.5%。其中，金屬切削工具機產出約為75億美元，同比增長13.6%；金屬成形工具機產出約為60億美元，同比增長8.9%。從上述資料看，2018年上半年中國大陸工具機消費市場呈現明顯增長的狀態。

而在第31屆中國機床工具產業發展論壇暨2019年運營形勢研討會上，中國機床總公司總經理梁楓也表示：“從重點聯繫的幾家工具機企業今年前8個月統計資料看，產業發展總體平穩、運行品質有所改善，主要經濟指標比較樂觀，市場需求保持一定的增速。”

## 工具機市場最新變化

毛會長還表示，金屬切削工具機需求數量受需求結構升級和去產能影響，近幾年需求指數均呈現持續回落的趨勢。2018年將會是近期消費需求量的低點。隨著在役工具機更新週期的到來和新動能的出現，2019年之後需求指數呈現穩步回升的趨勢。另外，由於需求結構升級明顯，近十年來金屬切削工具機平均價格明顯上升，未來工具機價值量的快速上升將彌補需求下降對消費額的影響，中國金屬切削工具機的消費額將呈現平穩增長的趨勢。

金屬成形工具機不同，更明顯地呈現穩步增長趨勢。這得益於金屬成形工具機的使用者市場與消費聯繫緊密，與金屬切削工具機相似的是，隨著工具機價值量的提升，金屬成形工具機消費額的增速將更加顯著。

## 產業內企業分化加劇

中國機械工業聯合會專家委員會副主任蔡惟慈在不久前的《當前機械工業運行形勢》的主題報告中指出，“當前形勢機械工業總體平穩，增速低於上年，但高於工業平均水準；同時穩中

有變，上半年微幅上行，下半年小幅下行，產業分化加劇。”他預計產業增加值、主營業收入和出口增幅略高於7%，利潤增幅將低於7%；明年增幅下行壓力大於今年，增速與今年相近或略低，外部壓力加大，出口不樂觀。”

蔡主任還進一步指出，從統計局資料看，工具機產業今年利潤增長較快。其原因可能與此前數年基數較低有關。其中金切工具機、切削工具、竹木機械

及其他專用設備、成形工具機增幅較高。而主營業收入利潤率則以切削工具、竹木機械及其他專用設備、功能部件較高，而金切工具機產業雖然利潤增幅看似不低，但利潤率只有4.92%，為各主要子產業中最低者，可見以通用工具機為主的金切工具機產業確實很艱難。

此外，蔡主任還表示工具機產業內企業分化劇烈，其中原因和啟示頗為發人深省。一是通用型金屬切削主機產業

企業形勢較差，但專用設備企業運營形勢相對較好——必須加快供給側結構改革。二是大陸國有重點企業技術積澱雖深，但多數比較困難。而長三角和珠三角等地區崛起的一批民營企業，能適應市場需求變化，較快地調整結構，在同樣的市場環境下卻景氣較好——改革出活力。■

來源：《國際金屬加工商情》



DISCOVER MORE WITH MAZAK™

TIMTOS  
台北南港展覽館1館1F  
Booth No. I0316

INTEGREX i-200S

INTEGREX e-420H-S

QUICK TURN 200MA

VCN-430A

QTG-50 SG

**Mazak**  
Your Partner for Innovation



台灣美捷科技股份有限公司

www.mazak.com.tw





# 數位化驅動生產力

**18**世紀的工業化與現在相比大不相同，那時的製造業主要依靠勞動密集型產業，直到20世紀“工業2.0”開始嶄露頭角，這一僵局才被打破。這場工業革命成功將電力引入到工廠車間中，使生產過程趨於標準化和高效化。接下來是“工業3.0”來襲，本次變革則是使用電子和資訊技術來代替人工工作，以提高生產力。

## 現代智慧工廠

今天，我們正處於“工業4.0”的交叉路口，而數位化革命已然使物理硬體和數位軟體之間的界限變得越來越模糊化。從人工智慧 (Artificial Intelligence)、增強現實 (Augmented Reality)、到物聯網 (Internet of Things)，再到高級工業機器人，科技正悄然改變著製造業的每一個工藝流程。而印度的製造型企業正希望像自己的鄰國中國那樣，通過降低生產設施和勞動力成本，提高

生產效率，促進產品多元化，從而搶佔更多的全球市場先機。

再過幾年，在製造產業中將很難看到車間工人使用複雜的機器來處理和完成簡單的任務，比如搬運重物。舉例來說，通用電氣公司 (General Electric) 在位於印度普納 (Pune) 的工廠中，引進了智慧車間 (Brilliant Factory) 的概念，這裡的工廠具有即時自我溝通和分享資訊功能，可以實現更快速更有效地決策。可以說這是下一代現代化、智慧化工廠的一個很好的範本。

## 製造商所面臨的挑戰

製造商需要對車間的運作方式有一個全面系統的認識，才能完成生產統籌規劃，從而更快地對市場需求做出反應，並在競爭中保持領先優勢。反之，如果他們仍然依賴於複雜而過時的製造管理系統來記錄和捕獲生產資料，必將引發一系列亟待解決的問題和挑戰。

大多數的生產車間，對於如何通過在設備上裝載感測器來抽取即時資料，

缺乏必要的知識和技術儲備，這就導致他們的設備故障診斷和避免停機的能力相對較弱。並且，大部分的生產設備都是在單一模式下工作的，這就無法在車間中形成有效的溝通機制。進一步說，工人的冗余、重複性工作任務會延遲回應時間，使生產過程變得緩慢而低效。

這是由於製造商一般不願放棄傳統的工藝流程，貿然採用新的工藝和技術。他們已經遇到了一些實際困難，例如在不同設備之間實現交互性操作，在生產週期中跟蹤相關資訊等等，這都是由缺乏靈活性造成的。

## 數位化技術正在使生產方式發生轉變

然而，有一個好的轉變正在發生。製造商們已經對雲計算、數位化分析工具和物聯網等新興技術表現出了濃厚的興趣，這些都可以作為他們重新定義和提高運營效率和盈利能力的強效工具。換句話說，這些新型技術，如人工智慧、物聯網、工業物聯網 (IIoT) 和3D

製造 (3D manufacturing) 正席捲整個製造業，並有可能通過自動化的工業流程徹底改變現有工廠的生產方式。

通過使用物聯網和各類感測器，能夠即時地提取到生產設備的資料，並對資料進行充分地整理和分析，最終這些資訊被發送到ERP系統，操作人員能夠通過這些資訊做出更明智、更準確的決策判斷。預測維護功能會根據溫度、壓力和其他參數對設備的健康狀況做出監測和評估，並就未來可能發生的潛在故障向操作員做預警提醒。

優化生產線涉及到許多複雜的問題。然而與以前相比，製造商現在擁有了更強大的資料獲取和分析能力。通過使用生產執行系統 (Manufacturing Execution System, 簡稱MES)，他們可以在生產車間裡完成很多的工作，例如，過程規劃、視覺化管理、工廠建模、操作模擬、資源選擇、遠端系統管理、工藝路線規劃等等。由KPIT公司提供的MES解決方案，能夠說明客戶有效實現生產效率的全球化，通過一個統一的製造管理平臺，其中包括



**源利電磁工業股份有限公司**  
Uni Magnetic Industrial Co., Ltd  
www.unimag.com.tw



TNEC Hall 2 R0908



**強力磁鐵過濾機**  
磁力高達5000高斯，過濾精度可達10µ！  
完全無耗材，因此只需一台即可滿足過濾的需求。  
適用弱磁性金屬，油性、水性切削液。  
The magnetic force is up to 5000 gauss, makes the filtration efficiency up to 10µ! No consumption at all. Applicable to weakly ferrous metal, oil-based or water-based coolant.



**移動式廢渣回收機**  
不需接電，不需停機，清潔時間短，體積輕巧的移動式廢渣回收機。  
適用金屬屑、非金屬屑、油性、水性切削液。  
None-demands in extra electricity and machinery stoppage, cleaning time shortened. This light and mobile scrap recycling machine is suitable for scraps of metal, non-metal, and oil / water cutting fluids.

**MAKING EXCEPTIONAL FILTERS FOR EVERY INDUSTRY.**



CE



ISO 9001  
FM 510619

+886-4-781 0900  
unicoltd@ms26.hinet.net  
彰化縣鹿港鎮彰濱工業區  
工業西六路23號

+86-021-5436 5295  
zhanghua@unimag.com.tw  
上海市徐匯區宜山路991弄19號102室



**ENERGY SAVING**  
SAVES 15% CUTTING FLUID



**HIGH PRECISION**  
HIGH FILTERING PRECISION



**ULTRA CLEAN**  
95% IMPURIFIED RIDDANCE





SINCE 1977

# UFO

One shank for 400 inserts



**Patent Tool Agent Wanted**



TWTC Hall1, A0424



Full profile thread milling



Double Corner Radius



Concave Radius



Partial profile thread milling



T-slot cutter



Radius Insert



Chamfer Insert



Circlip Insert



Dovetail Insert

**YIH TROUN ENTERPRISE CO., LTD.**  
www.cut-tools.com.tw

+886-2-8521-3035  
ytservice@cut-tools.com.tw  
No. 1, Lane 403, Hua-Cheng Rd., Hsin-Chuang,  
New Taipei City 24253, Taiwan



30

第二天 | 2019年3月4日-9日





產品生命週期管理 (Product Lifecycle Management, 簡稱PLM)、企業資源規劃 (Enterprise Resource Planning, 簡稱ERP)、製造運營管理 (Manufacturing Operations Management, 簡稱MOM) 和車間控制四大模組, 為工廠運作提供即時的、可見的資訊支援, 以改善和優化決策方式。

### 集中化決策

上述的各種數位化措施使得生產決策具有集中化趨勢, 這一特徵對於以較低成本為前提尋找提高效率和生產力方法的全球運營商來說無疑是非常對胃口的。

利用ERP、MOM、PLM等製造管理工具的集成化解決方案, 可以有效提高車間生產效率, 減少時間成本, 平衡工作負荷, 達成高級計畫和驗證目標, 找到並執行理想的製造實踐方案以減少生產不確定性, 實現生產資料同步流動來減少庫存, 加強無紙化運營以減少召喚、保修和責任成本, 在無需原型機的條件下以虛擬方式完成驗證流程, 提高生產力, 更好地利用資源, 並減少產品上市的時間。

基於智慧眼鏡技術的免人工倉庫拾取解決方案, 利用了增強現實AR技術, 已經成為生產車間的又一強力武器。在傳統車間裡, 裝卸物資可能需

要花費一個小時的時間, 在此期間先要獲得過程批准, 接下來還要更換物資標籤以達到和內部識別系統相匹配的目的, 最後還要將物資放置到正確的位置上。集成了AR技術的智慧眼鏡能夠快速引導工作人員到達正確地點, 因此可以節省工作時間, 減少出錯率和費用成本。由KPIT公司推出的KwikPick解決方案, 能夠幫助工人提高物資的運輸速度和放置準確性, 使整個倉庫拾取過程更加流暢。

### 未來的生產車間

隨著工業4.0時代的不斷臨近, 對於

高技能勞動力的需求也會不斷加大, 這是因為他們有創建和實施新的生產製造管理系統的經驗和能力。要實現工廠的高效化生產, 製造企業必須具有超前意識, 不斷提升和擴展員工的技術和能力。

根據印度聯合工商會 (ASSOCHAM) 的最新研究報告, 印度政府提出的“印度製造”計畫將致力於提升國家製造業的整體實力, 其目標為將製造業在GDP中所占的份額從目前的16%提升至25%。此外, 這項計畫還期望在2022年到來之前創造一億新的就業機會。

製造商正積極開展數位化平臺的創建工作, 屆時生產設備和操作工人可以即時交換資訊, 設備的功能將得到大幅提升, 傳統的生產生態系統將發生徹底改變。不斷湧現的新技術正為製造商開啟一個自動化生產新紀元, 在這樣的大趨勢下, 人力和機械設備的協同工作將變得越來越頻繁。

工業機器人、人工智慧和機器學習技術的不斷深入和成熟, 使得自動化設備能夠在製造過程的方方面面為生產助力。那些正在進行自動化革新或尚未開始這一旅程的製造企業必須權衡利弊, 評估出適合自身發展的自動化程度目標, 以獲得理想的投資回報。■

來源:《國際金屬加工商情》

MADE IN TAIWAN

**CHG** 詮豐精密工具股份有限公司  
CHUNG HONG PRECISION TOOL MFG.

▶ 線性傳動的新領域

www.chpt.com.tw

PAT.

Planetary Screw Assemblies  
行星式滾柱螺桿

**TIMTOS** 2019.3/4~3/9  
Nangang Hall 2, S0207

Kaohsiung	+886-7-6381281	chggauge@gmail.com
Taichung	+886-4-22421981	chggauge@gmail.com
China	+86-21-59136471	shqfpt@126.com
Thailand	+66-2-7504225	chgthai@gmail.com

**LCH**  
High Speed Eco Servo Press

連傑油壓  
3000

Energy Saving  
Noise Reduction  
Higher Production Rate

LCH-ES

**eco**

**72<sup>nd</sup>**  
anniversary  
Press Expert

**TIMTOS**  
TWTC Hall1 1F D0501

**LCH** 連傑油壓工業股份有限公司  
LIEN CHIEH HYDRAULIC INDUSTRIAL CO., LTD.  
No.97, Baoxin St., Xizhi Dist., New Taipei City 22173, Taiwan  
Tel: +886-2-8648-3000 ext.320 Fax: +886-2-8648-2000  
lienchieh@Lch.com.tw www.Lch.com.tw



參展商採訪

# 迪斯：高效的2,500噸汽車衝壓生產線

以生產高品質的精密油壓機械著稱的迪斯攜2,500噸汽車衝壓生產線亮相今年的TIMTOS展會。

據迪斯油壓工業股份有限公司業務處經理李琳富先生介紹，該汽車衝壓生產線可配合重型機器人、快速換模系統、送料系統、清洗機進行殘料自動輸送收集，其左右側雙移動檯面可節省換模時間。該產線全年無休，且24小時自動生產，使用者可以按照特殊的生產需求調整速度以及設定緩衝系統。該汽車衝壓生產線使用者美國福特市場佔有率在全球已超過10%，為汽車製造產業世界前三大廠之一。

如今，汽車衝壓領域的產品日趨向

高精細化、加工自動化、控制電腦化發展。迪斯研發的HD系列的高速科技，由蓄壓器控制快速加壓速度達30-150mm/sec，下降速度可達800mm/sec，上升速度達600mm/sec或更快，解決了深抽成型效率低的既有問題。

臺灣迪斯油壓工業股份有限公司創建於1976年，是亞洲專業生產油壓機械、無人化生產線以及各類油壓衝床、油壓成型機的重要製造商，歷經四十餘年的成長及發展，公司本著“品質穩、交期準、服務快”的經營理念以及一貫化的製造理念為客戶創造優質及高附加價值的油壓機。加上其多年製造經驗與不斷的和日本及歐美先進技術交流，現

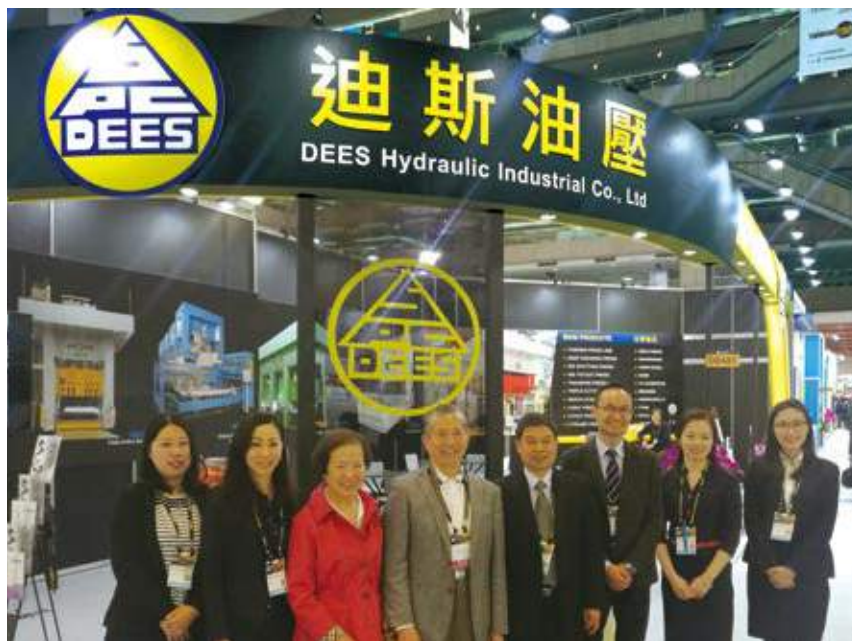

已擁有高度的設計製造技術、嚴格的品質管制體系及優良的售後服務功能，公司已通過了ISO-9001=2015質量認證及機台之CE安規認證，為客戶提供安全及易於使用的操控界面。

迪斯的油壓機覆蓋10噸到6,000噸，生產機台總量累計超過4,500台，成功進軍各大汽車廠及配套廠，已上線衝壓生產線50條，至今已銷售至世界80個國家。經過迪斯的不懈努力，其工具機銷售給了龐巴迪、波音、本田、豐田、

奧迪、大眾、賓士、沃爾沃、博西華集團、伊萊克斯、奇異家電、海爾、富士康等客戶，為其製造汽車、奇異家電、電子、航天相關產品賦能。

“為客戶增加附加價值，迪斯永不懈怠。”李琳富先生總結道。

**迪斯油壓工業股份有限公司**

電話：+886-2-2601-8661

郵箱：sales@spc.com.tw

網址：www.deesgroup.com.tw

攤位號碼：D0401



# 新穎機械：回歸客戶的實際需求

此次展會，新穎機械攜旗下五軸同動的大型加工機——重切削型CNC五軸龍門加工中心機參展，特適於鈦合金或其他難削材料之多軸同動加工。該設備主要應用於航太產業及難削材料之各種曲面加工或特殊角度加工切削。

與上屆參展產品不同，此次新產品之Z軸與Y軸滑動件具有切削振動抑制的結構專利設計，在加工條件中能得到更好的切削表面及切削速度，縮短加工時間，同時降低刀片的消耗。全機身採高剛性結構體設計，機械式同動二軸頭，BC軸傳動採蝸桿蝸輪傳動，搭配自製重切削式兩段變速齒輪箱，加工齒輪模數加大(M=3.5)，齒數比1:1.75及1:7及齒輪

式傳動主軸設計，最大重切削扭矩可達到1155N·m。

此外，全封閉式防濺鍍金護罩，摺疊式操作門且具備超大門寬設計，整體外觀更結合時尚美學及安全防護的人因設計。橫樑安全護欄設計，保護維修人員安全，方便機械維修作業。升降式懸臂操作箱，可隨時調整高度，配合操作者所需。

利益於产品研发創新，新穎機械在2018年取得了較2017年成長2倍的業績，新穎機械董事長莊茂賓介紹說：“產品研發本是公司未來生存的命脈，但新產品的方向仍然在於客戶的需求，因此我們必須知道全球產業發展的趨勢，然後



去選擇一個認為可以跟同業競爭，甚至超越同業的產品，並奠定這產品在用戶端獲得比同業更好的評價。”未來，新穎機械也將繼續以航太，汽車，機械製造的產業為業務主要方向。

對於時下最熱絡的工業4.0話題，莊茂賓董事長也表示，這確實是時代的一個趨勢，進入這個時代，勢必帶來更人性化、更加智慧、節能的製造方式與不同客制化的需求，因此產品要有競爭力，要能得到客戶認同。“我認為產品的任何功能、品質，最終還是要回歸到客戶的實際需求面，目前智慧製造的發展進

程，每個企業一定要參與其中，才能與他人並駕齊驅。”

展望未來，新穎機械將秉持「專精、創新、實踐」信念，不斷革新求變，以符合市場需求，並以科學管理增進效率，提高品質穩定性及最完善的服務系統，使「高品質、高效能」的新穎機械能深得客戶的讚賞、信賴與肯定。

**新穎機械工業股份有限公司**

電話：+886-4-2562-8000

郵箱：sigma.cnc@msa.hinet.net

網址：www.sigmacnc.com.tw

攤位號碼：南港2館1樓 P0814





## 健椿：值得信賴的高速主軸專家



由靈敏的客製化研發與改良實力，能夠完全的因應各種市場變化中的需求。未來的市場策略中，健椿會持續開發高品質、低失誤率的主軸使工具機在工業4.0的趨勢下運行得更為順利，並且大幅延長機械的壽命。除了提供產線最佳效率，也幫助機械系統至自動化及智慧化的主軸方向前進。TIMTOS 2019 年的主題依舊定調為展現智慧製造的未來藍圖，智慧化和工業4.0的背後終究得

依靠穩定的主軸與刀具系統，健椿的主軸與刀具一步步的引領新時代製造業趨勢，以強勁的心臟主軸滿足工業科技的快速變化，輔助工業升級。

**健椿工業股份有限公司**  
 電話：+886-4-7910-271  
 傳真：+886-4-7910-272  
 郵箱：cnc-spindle@kenturn.com.tw  
 網址：www.kenturn.com.tw  
 攤位號碼：Q0804

**健**椿工業在2015年啟用15000坪彰濱二廠，擴大營業，並於2018年股票上櫃買賣。過去35年，健椿以精密主軸的生產為全球工具機設備提供了最強而有力的心臟，近年，健椿除了不斷提升主軸的研發與製程能力，也擴大生產精密刀具（ECIO）。健椿使用的生產設備來自德國、瑞士與澳洲等精密設備，加上精密的量測設備輔助確保高精度的生產。健椿將在TIMTOS 2019再度展現他們在綜合加工機精密主軸、專用機主軸的進化。除了優化既有的產品線-皮帶式主軸、直結式主軸與內藏式主軸，他們積極往高端內藏式主軸研發，幫助主軸實現轉速高、溫升低的特性。因應市場需求推出搖擺頭主軸，為客戶提供高難度工件加工最佳利器。除主軸本身具有高穩定度/高精度等特點外，並搭配振動智能監測感知系統，將主軸效能相關資訊即時反饋給操作者，主軸本身也能夠協助執行自我診斷，並擷取服務資訊，讓主軸產品在維持在最佳使用狀況外，也能感測軸承退化/異常撞擊等現象，為主軸性能做及時把關。ECIO刀具則著重於提供使用者難切削材料的刀具與客製化特殊刀具。ECIO刀具目前已研發出近千種產品類別，主要精密刀具類別為鎢鋼立銑刀、鎢鋼球刀、鎢鋼圓鼻刀、鎢鋼成型刀、鎢鋼錐度刀等刀具。

健椿在TIMTOS 2019展示運用於銑床、車床、磨床的高精密主軸，以及上述全新系列ECIO 自有品牌刀具。未來健椿會朝向具備高轉速、新型冷卻系統、溫度感知系統的智慧主軸開發。健椿對國際市場有十分紮實的佈局，藉



**精密、卓越工具機领航家** 龍門·五面·五軸專業製造

**SDV-HLA系列**  
 CNC高精密龙门加工中心机 with 自动分度万向铣头模组  
 直结式主轴10000rpm, 两段变速行星式齿轮箱, 最大输出扭力可达907/770Nm

**特色：**高刚性正交式自动方向铣头  
 BT-50, 3000rpm,  
 C轴自动最小定位分度5°(1°), ±270°  
 A轴自动最小定位分度5°(1°), ±90°  
 重切削移除率最高可达640cm³/min

**55A-4732HH (TIMTOS展示机)**  
 CNC五轴龙门加工中心机 - 重切削型  
 特适用于钛合金、不锈钢或其他难削材料之多轴同动加工

**TIMTOS 2019** Mar 4-9  
 27th Taipei Int'l Machine Tool Show

**Booth No. P0814**

**新穎機械工業股份有限公司**  
 台中市神冈区庄後里大圳路53号  
 Tel: +886-4-25628000 / Fax: +886-4-25621493  
 E-mail: sigma.cnc@msa.hinet.net

[www.sigmacnc.com.tw](http://www.sigmacnc.com.tw)



參展商採訪

# 盈錫：做世界的「零件供應重鎮」

本次展會，盈錫帶來了新推出的「軸向力感測器」，該產品專為主軸用精密螺帽設計，其功能正是用以測量精密螺帽在鎖緊時，施予扭力後會有多少軸向力施壓在被鎖物上。除此之外，還可自行檢查主軸在組裝時的品質是否穩定，進行軸向力資料的比對，目前產品提供三種規格，並配合專用上下墊圈，可測量M40至M170的螺帽軸向力，其可量測的最大軸向力為4000kgf。

一直以來，盈錫專注於「精密螺帽」生產製造與銷售，主要產品有：SBL系列精密平衡螺帽，YSPL系列精密鎖定螺帽，油壓螺帽，SGL精密平衡螺帽，YS系列精密平衡螺帽，廣泛應用於高速化工具機主軸、木工機、印刷機等設備。

台中盈錫成立於1989年，以所謂『黑手業』的傳統代工起家。草創時期由董事長林國華於台中廠房，代工精密零組件及生產等。



二十多年的歲月，盈錫精密在巫有崇總經理的帶領下，本著「永續、成長、卓越、誠懇」的經營策略，建立起大台中製造基地，全球七大行銷服務中心版圖。從傳統走向高科技精密產業，秉持品質至上、服務第一理念，邁向『小零件成就大世界』，成為世界的零件供應重鎮。

目前，盈錫不僅引進了高精度生產

設備，更創立了業界第一間「精密螺帽研發及檢測實驗室」，致力於為更多用戶提供零缺點、高品質的產品與服務。

盈錫精密工業股份有限公司

電話：+886-4-2244-7899

傳真：+886-4-2245-2402

郵箱：service@yinsh.com

網址：www.yinsh.com

攤位號碼：南港2館 R0814

## HOSEA HOSEA PRECISION CO.,LTD.

Tel: 04-2531 9551 http://www.hosea-world.com  
Fax: 04-2535 5734 Email: sales@tanshing.net

### CNC ROTARY TABLE

TIMTOS 2019 Mar.4-9  
27th Taipei Int'l Machine Tool Show  
南港展覽館二館4樓 R0818



HOSEA PRECISION CO., LTD. has been exporting 5 Axis rotary tables for over 15 years and we are the leading supplier of this type of export controlled product.  
Over 300 5 Axis Rotary Tables Per Year exported from our Taichung manufacturing facility.

We are the **Largest Supplier** of 5 Axis rotary tables in Taiwan.

Hosea becomes first Taiwanese rotary table manufacturer to obtain AS9100D certificate



#### ACR-4040、APC-400

##### Higher Productivity

Through high-speed exchange of the tray to reduce exchange time from 15 sec to 6 sec.

##### More Concise Mechanical Design

Only through the cam mechanism, you can complete tray ascending, descending, and other actions.



## EVERISING

TIMTOS 2019 Mar.4-9  
TAIPEI NANGANG Exhibition Center, Hall 1  
BOOTH NO.:10408



E-830

**I TECH SAW**  
SAW YOUR IDEA

E-530



**A sawing database with 60000 entries**  
**Decrease defect rate** Increase production speed



P-501LA



www.everising.com  
evrs@everising.com.tw  
+886-4-2359-3178





# 只需1秒加入,與目標潛在買家聯繫

超競爭時代

要使用哪種方式觸及目標買家?

## 內容決定品牌影響力

為什麼選擇故事行銷?

在當今的資訊時代,各類資訊鋪天蓋地。在浩如煙海的資訊中,如何使你想被人看到的資訊不被淹沒?這就需要有好的故事行銷來突顯你的產品了。除了好的內容之外,還需要有良好的平臺和管道來幫助你迅速推廣,獲取有效銷售資源。

**CREATE  
PROMOTE  
ENGAGE  
OPTIMIZE  
STRATEGY  
ANALYZE  
MARKETING**

全媒體行銷整合策略幫助您建立溝通的橋樑、找到中國、東南亞以及全球潛在買家,並提升品牌價值

### 專業編輯團隊

由榮格的專業編輯與攝影團隊為您定制內容(文章X影片)。

### 正確管道

內容發佈於社群媒體、網站、電子快訊與雜誌

### 目標受眾貫穿全產業鏈

在適當的時間,以適當的媒體形式,接觸到正確的人,真正觸達產業鏈中的決策者

通過4大管道,迅速傳遞您的故事內容,有效觸及9大產業的目標買家

覆蓋9種產業  
+  
2大市場

★醫療設備、金屬加工、工業鐳射、感測器、工業機器人、汽車、航空製造設計、智能製造與工業設備產業  
★中國與東南亞市場

4大宣傳管道



平面與電子版

紙感閱讀  
工業雜誌

174,000+  
訂閱戶



分享再分享  
社群媒體

45,000+  
粉絲



主動出擊  
電子快訊

317,000+  
訂閱戶



拉式推廣  
網站

306,000+  
月均獨立訪客



立即聯繫  
獲取專案服務優惠價格  
sydneylai@ringier.com.hk  
886 23297318

通過案例分享讓您更了解



金豐機器工業股份有限公司



產品報導

**帶鋸機H-360HB**

合濟鋸床，始終具有最可靠的質量，並具有最大的穩定性和故障異常排除。H-360HB全自動雙柱式帶鋸機，結合了重型結構更耐用。結合複合材料切削，鋸輪設計能夠切割最大360mm始終為您提供良好的鋸切性能。以P.L.C.控制電氣和液壓功能，使您擁有一台穩定的生產機器。夾鉗夾緊系統，鋸框升降，下降進給和上壓系統均由更為穩定的液壓系統進行控制；帶鋸有鑄鋼片及滾輪軸承引導，提供剛性並減少振動，通過變頻器進行鋸帶速度控制，可調節進給速度和進給壓力，使操作者可以在鋸切不同材料時有更完美的鋸切及更長的鋸帶壽命。H-360HB型號是中小型帶鋸機市場上最好的帶鋸機之一。

合濟的重型切削帶鋸機是以市場上的最高標準建造的，機器的高切削性能始終是您的首選。



**合濟工業股份有限公司**  
電話：+886-4-2350-5300  
傳真：+886-4-2350-5420  
郵箱：evrs@everising.com.tw  
網址：www.everising.com  
攤位號碼：I0408

**馬波斯機床防護系統**

在機器、設備或是機器人中發生的碰撞或是撞擊經常會導致大量的損壞及導致高成本，維修費用昂貴，最重要的是生產停滯不前。馬波斯GEMCMS02機器防護系統憑藉可靠檢測碰撞及撞擊，可立即停止相關的驅動器，其反應的時間小於1毫秒 (<1ms)，可大大減少甚至防止損壞。

優勢：應變感測器，易於安裝和改裝；適用非常慢(靜態)及快速進給檢測碰撞；減少損失；延長機器壽命；降低維護成本；報警數據記錄，進一步用於評估及分析。

GEMCMS02系統是為獨立使用而開發的，易於整合到ARTIS GENIOR MODULAR及製程監控系統中。

**馬波斯精密股份有限公司**  
電話：+886-4-2262-2340  
傳真：+886-4-2262-2402  
郵箱：sales@tw.marposs.com  
網址：www.marposs.com  
攤位號碼：南港2館 P0320



**側固式主軸**

- 特性：
1. 超高精密與高剛性軸承，可承受軸向負載以及傾覆力矩。
  2. 超精密光學編碼器，極佳的定位精度與重現性。
  3. 背隙可調。
  4. 旋轉中心出線，簡約美觀。
  5. 依客戶需求，可搭配各種主流廠牌控制器與伺服馬達。



應用：

1. 適用於五軸加工中心機。
2. 適用於航太工業、汽車引擎等複雜零件加工。

**矩將科技有限公司**  
電話：+886-4-2239-2345  
傳真：+886-4-2239-2357  
郵箱：microlab@twspindle.com  
網址：www.twspindle.com.tw  
攤位號碼：南港2館Q1212

**天車式高速五軸龍門加工中心**

Compact B 歷經千錘百煉，給您最好的汽車模具五軸加工中心！

擁有4大機床特色：箱中箱對稱式橫梁結構、全對稱立柱及底座一體式設計、線性馬達驅動60m/min高進給、以及扭矩電機驅動二軸頭。

箱中箱對稱式橫梁結構是對抗環境溫度的最佳設計，因主軸中心配置於橫梁及滑枕中心，可把車間環境溫度變化而造成的熱變位(跑中心)減至最小。

全對稱立柱及底座一體式設計，可提供絕對的剛性，並確保精度和機械性能的穩定性。

線性馬達驅動帶來高速及高精度的加工品質，相較於傳統的螺桿驅動系統，可避免背隙及磨耗的問題。

扭矩電機驅動二軸頭除了同樣擁有無背隙、無磨耗的特點外，結構簡單的模組化設計，讓維修快速方便，並降低維修成本。



**大前科技股份有限公司**  
電話：+886-4-2565-3080  
傳真：+886-4-2565-3090  
郵箱：info@kencnc.com  
網址：www.kencnc.com  
攤位號碼：I0616

**模塊化雙主軸工具機VL 150 DUO**

VL 150 DUO集近年來的技術創新成果於一體，包含自動上下料系統、TrackMotion自動化系統以及工具機的模塊化基本結構，組成了高效的生產系統，在緊湊的空間內實現了生產效率的最大化。該工具機擁有互為鏡像的兩個工作區，實現了對VL系列產品範圍的完美拓展，是高效加工直徑達150 mm 圓盤類零件的理想之選。

該工具機可選配埃馬克專有的TrackMotion 自動化系統。該自動化系統極為緊湊，且直接安裝在VL 150 DUO工具機加工區後方，可方便地提供高效加工的一切所需：可容納多達400個工件的工件存儲器以及在各加工站之間快速傳送工件的工件傳送系統。

VL 150 DUO 的每個加工區中也配備有獨立的工件臨時存儲器和上下料主軸。鏡像排布的加工區分別裝有獨立的工作主軸，其功率和扭矩分別可達 17.9 kW 和 144 Nm，充足的功率可保障快速且精準的切削。此外，每個加工區都配備有 12 刀位刀塔，刀塔上除了車刀外還可裝配動力刀具。



**埃馬克(中國)機械有限公司太倉分公司**  
電話：+86-512-5367-6146  
傳真：+86-512-5357-5399  
郵箱：info@emag-china.com  
網址：www.emag.com  
攤位號碼：世貿一館1F C0224

**100kva全自動洩壓閥焊接機**

型號：DDIA-100-VLV  
功能：全自動化焊接與組裝洩壓閥所有物件

- 特色：
1. 彈簧放入工作站後，工作站可將彈簧個別分開，進行全自動化的洩壓閥組裝與焊接。
  2. 三相變頻直流確保優越的焊接品質與強度。

**大慶電機工業有限公司**  
電話：+886-6-593-2646\*19  
傳真：+886-6-593-5555  
郵箱：lily@dahching.com;  
service@dahching.com  
網址：www.dahching.com/en  
攤位號碼：C0938

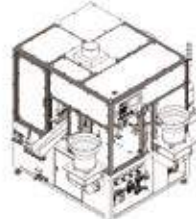

**傳動軸**

型號：TYL系列\TYB系列\TYB-S系列  
功能：1. 用於橡膠廠膠布機。2. 用於鋼鐵廠壓延機械。

- 特性：
1. 彎曲角度可達15度
  2. 高負重能力
  3. 長度可調整
  4. 三種型式可供選擇：輕負載用、中負載用、重負載和超重負載用



**天益齒輪股份有限公司**  
電話：+886-3-5970-206  
傳真：+886-3-5970-210  
郵箱：tien0206@ms15.hinet.net  
網址：www.tienyigear.com.tw  
攤位號碼：G0231

**極小型斷電煞車器**

型號：MBS系列、PB系列

功能：針對彈簧式斷電刹車及永磁式斷電刹車研發出極小型的設計，直徑小於20mm，最小扭力僅為0.04 Nm，並搭配客製的鎖固尺寸，讓客戶在安裝時選擇更為彈性。新產品上市後獲得極大迴響，廣泛應用於智慧化製造以及產業用機器人，在國內外皆創造銷售佳績。其中MBS為超薄型過激磁安全刹車器，超薄型的設計不僅能節省安裝空間，且搭配過激磁控制器可發揮其高扭力和低消耗功率的優越特性，有效降低刹車器溫度。永磁式刹車器是用永久磁鐵代替彈簧作為制動力的提供，因此有別於一般的彈簧式安全刹車器。

永磁式安全刹車器是由電樞和板片彈簧作組合，所以當斷電制動時是無背隙的，而送電空轉時也不會產生空轉扭力。

特色：超薄型過激磁安全刹車器(MBS)特性：配合馬達框架設計，容易安裝、薄型化設計，節省空間、高扭力、低消耗功率。

永磁式(PB)特色：反應快速、無背隙、低噪音、小體積高扭力。

**仟岱有限公司**  
電話：+886-4-2335-3024  
傳真：+886-4-2335-4027  
郵箱：ct.salestw@msa.hinet.net  
網址：www.chaintail.com  
攤位號碼：S1414





### 多工位全自動生產線

型號：LCH-LDH

功能：透過LCH獨家人機操作介面，整線可以在無人化的狀況下，實現從鈹材清洗到成品成形之一線包辦。

特色：最新3D視覺定位系統；六軸機器手臂；自動送料系統；高品質清洗機；全自動生產；提高生產效率；降低人事成本。



連傑油壓工業股份有限公司

電話：+886-2-8648-3000

傳真：+886-2-8648-2000

郵箱：michael\_wang@lch.com.tw

網址：www.lch.com.tw

攤位號碼：D0501

### 飛剪裁切生產線

型號：T5RS1600W

功能：拓誠機械提供具有最先進的技術的剪切生產線以及分條生產線給各種不同的金屬裁切中心，例如：中碳

鋼、不銹鋼以及其他很多不同材料的金屬裁切中心。拓誠機械的剪切生產線以及分條生產線提供了最先進歐洲技術的解決方案。我們處理各種不同的材料、板金，包含了不銹鋼材、鋁材、熱軋鋼、冷軋鋼以及經過表面處理的鋼捲。

特色：憑藉著世界領先的控制系統，我們提供了能源再生(DC BUS)，將生產過程中所產生的電能分配到生產線中其他站別並使用多軸伺服控制系統以確保整條生產線的同步控制。透過我們機械與電控系統中的創新研發團隊，可確保我們的客戶不只可以獲得機械設計上的解決方案，還可為了不同應用提供完整的機電整合系統解決方案。拓誠機械專精於裁切生產線型態包含了停剪生產線、圓盤剪生產線以及追剪生產線。鋼捲分條生產線也提供多一組分條刀座，來確保高生產率。



拓誠機械股份有限公司

電話：+886-3-359-5628\*173

傳真：+886-3-359-5629

郵箱：salestech@toptran.com.tw

網址：www.toptran.com.tw

攤位號碼：D-0212

### 金屬研磨機

型號：RDB-06

功能：RDB-06機型 - 搭配兩個研磨頭，可旋轉180度切換不同的研磨刷輪。快速去除工件上的毛邊，相當適用於鑄射切割後製加工。工作桌面還可加裝磁盤來吸附鐵材或選用真空吸盤來固定薄料工件。



特色：

1. 快速簡易-更換砂帶、刷輪耗材簡單不耗時
2. 操作方便-設計符合人體工學，大幅降低操作人員體力的耗損
3. 效率提升-使工廠生產流程順暢快速，優化產品品質

勝榆機械有限公司

電話：+886-4-2522-0948

傳真：+886-4-2522-0648

郵箱：w1954@ms21.hinet.net

網址：www.worldmax.com.tw

攤位號碼：M0606

### 聚晶鑽石&氮化硼刀具研磨機

型號：PP-DM

功能：可研磨R型及各角度之聚晶鑽石&氮化硼材質刀具。

特色：本機專為聚晶鑽石&氮化硼刀具設計研發。本機採用陶瓷砂輪，一般材質的研磨砂輪，無法研磨聚晶鑽石&氮化硼刀具，再加上此類刀具價格高昂，研磨時須特別注意。針對特殊角度，本機附有CCD，可在研磨R角時，透過螢幕之輔助使研磨更精準。另外，本機砂輪馬達附左右往復之功能，研磨刀具時省力又省時。

北平精密企業有限公司

電話：+886-4-2358-9088

傳真：+886-4-2358-9098

郵箱：service@pei-ping.com

網址：www.pei-ping.com

攤位號碼：N0003



## Micro Electric Power-off Brakes

極小型斷電煞車器

**HOT NEW ARRIVAL**

Smaller in diameter than 20mm



Spring applied Brake  
微型彈簧式斷電煞車器

Permanent Magnet Brake  
微型永磁式斷電煞車器



CHAIN TAIL CO., LTD.  
仟岱有限公司 since 1984  
www.chaintail.com

**TIMTOS**  
2019.3/4-3/9  
Nangang Hall 2, S1414



No. 305, Lane 460, Sec. 1, Hsianan Rd.,  
Wujih Dist., Taichung City, 41462 Taiwan  
TEL: 886-4-23353024 FAX: 886-4-23354027

## IT'S ATTITUDE.



Right tool for right job.

High speed cutting tools  
Drilling tools & Boring tools  
Turning & Milling Accessories  
Roughing Milling Cutter  
Fine boring system  
Wrench stellar & Wrench Hexagon

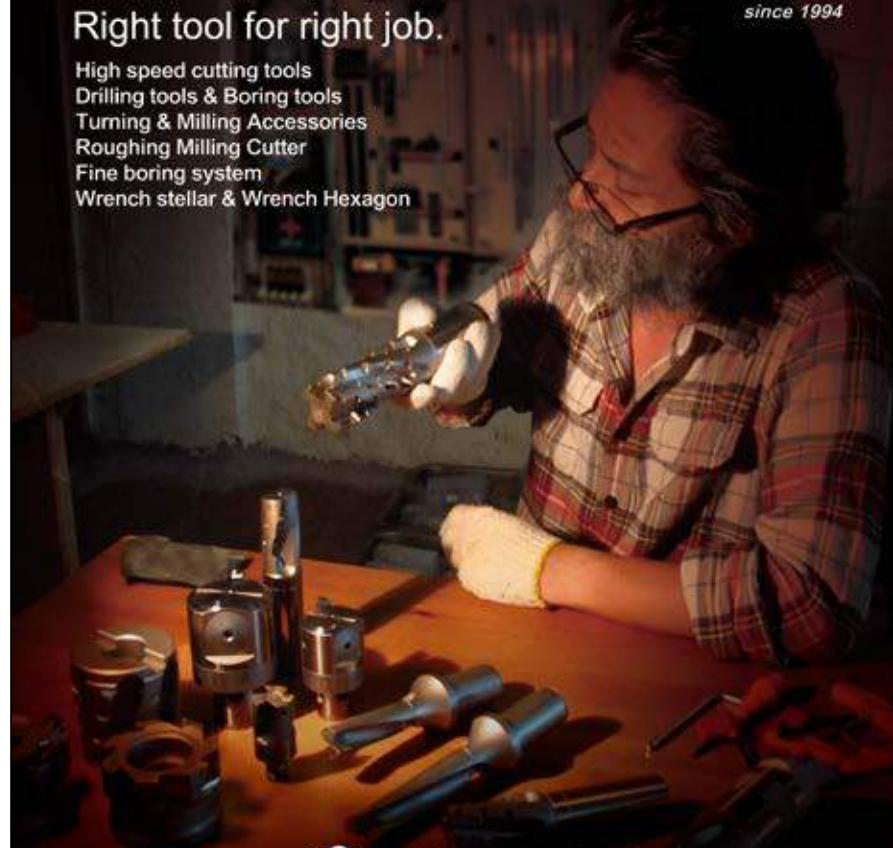

**TIMTOS**  
TWTC Hall 1F A0121

WEI GUAN CUTTING TOOLS CO., LTD.  
緯冠刀具有限公司  
No. 463 Tafeng Rd., Tali District, Taichung City, Taiwan

886-4-24929135 info@wei-guan.com.tw  
886-4-24929256 www.wei-guan.com.tw



產品報導

捨棄式鋸片

型號：鋸片系列

功能：主要側銑刀把專用，使用者在選購此一刀盤時，直徑選購越小越好，因側銑刀把直徑較小，且長度較長，選購直徑較小的刀盤，有助於提升加工的穩定性及刀片壽命。

特色：1. 單一刃口及專利排屑溝槽設計，有效降低加工阻力。2. 特殊刀片材質CE60具有良好抗熱及耐磨性。



益壯企業有限公司

電話：+886-2-8521-3035

傳真：+886-2-8522-3039

郵箱：a003@cut-tools.com.tw

網址：www.cut-tools.com.tw

攤位號碼：A0424

大型沖床落料線

順達的大型沖床落料線針對汽車和製造產業的高質量需求而設計，為鋼卷

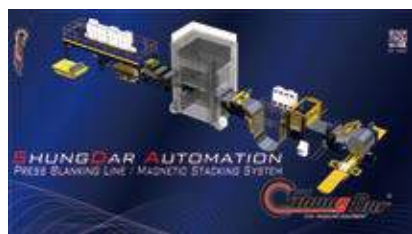

和鈹材堆垛操作提供全面的加工解決方案，採用西門子伺服控制驅動系統和模組化機構，實現高度自動化的生產線，包括自動上料、通鈹和堆疊。生產線參數由資料庫控制，機械動作調整可以通過資料下載和確認同時執行，提供操作員的安全性和操作效率。多個台車和雙堆疊系統可讓機器不停機，確保在最大運作時做好安全準備。

此外，使用這種技術的生產線非常適合加工多樣化的材料，如鋁或高強度材料。甚至表面敏感材料也可以確保在高效率生產下能順利加工。

憑藉在汽車沖壓送料設備領域的豐富研發技術和經驗，在臺灣的鈹材沖壓設備製造商中建立了新的國際競爭力。

順達實業股份有限公司

電話：+886-4-7622-020

傳真：+886-4-7622-022

郵箱：shungdar@ms17.hinet.net

網址：www.shungdar.com.tw

攤位號碼：C0310

行星式滾柱螺桿

詮豐精密專業製造螺紋規已有40年之經驗，透過技術、加工及設計整合，成功解決行星式滾柱螺桿中重要的滾柱超精密螺絲關鍵元件，同時開創臺灣在全球線性傳動的新領域、新地位。行星式滾柱螺桿主要結構為行星式螺桿、高精密螺絲、螺帽，具線性運動精度高、高剛性、出力大、壽命長、高負載、低背隙、低噪音、定位精準等優異表現，已成為精密產業定位及測量系統上的重要零件之一。

滾柱螺桿使用柱狀滾動件來取代滾珠，比一般滾珠螺桿擁有更大負載能力、更長的使用壽命、更小的導程。且滾柱螺桿無需回流裝置，可達到比滾珠螺桿更快的轉速，並降低噪音值。行星式運動就像行星繞著太陽公轉一樣，縱使在浩瀚宇宙億萬星球，天體運轉繞行軌跡絲毫不差，行星式滾柱螺桿藉由螺桿與精密螺絲介於螺帽間的運動，將螺桿之滑動由螺絲嚙合轉換、回轉運動，轉為直線運動的傳動機械元件。其堅固的機構設計可適用於各種不良環境中。適用於全電式塑膠射出機、伺服衝床/折床、拉床、3D列印等高速高負載、高精度機構應用。



詮豐精密工具股份有限公司

電話：+886-7-6381-281

傳真：+886-7-6381-103

郵箱：chggauge@gmail.com

網址：www.chpt.com.tw

攤位號碼：南港2館S0207

五軸加工中心機

型號：U6

功能：應用於汽機車零件、3C產品、葉輪、航太零件、醫療用品(如齒模、人工關節)等高科技工業用零件。

特色：U6機種是集聚高精度、高速度、高效率及高科技控制技術於一身，並兼具最佳性價比，其設計概念乃透過穩定的標準化機台和高可靠度搖籃式分度盤的整合結構，4/5軸加裝光學尺以提高加工精度品質，其優異的加工性能是您進入五軸加工領域的不二選擇。

高效率：搭載西門子840Ds高性能控制器可應用從簡單至複雜的各種五軸同動加工。



高精度：X/Y/Z三軸線軌+B/C軸加裝高精度光學尺，B軸傾斜角度範圍+90°-120°，C軸轉動角度範圍360°，B/C軸工作臺水準最大載重300KG。

高速度高扭力主軸：12,000轉直結傳動，扭力最大可達60NM。

大容量刀庫：鏈條式刀庫可裝載32把刀。

馬特工業有限公司

電話：+886-4-2525-0480\*202

傳真：+886-4-2525-7747

郵箱：claire@macocnc.com

網址：www.macocnc.com

攤位號碼：K0322

精密金屬分條機

型號：TDS-700

功能：將寬幅的金屬及特殊合金捲料分條成各種窄幅成品捲料帶(舉凡鋼鐵、不鏽鋼、鈦合金、鎳基合金、複合材、銅合金及鋁合金皆能迎刃而解)。



特色：道德分條機具備高剛性、高精度，能長久穩定地提供良好的裁切品質；分條機搭配道德產製的分條刀及鋼套配件平均可節省近40%的排刀時間；提高生產稼動率，降低成本及不良率，創造額外的附加價值；從原材廠到分條加工廠都能適用的各種分條解決方案；47年不間斷生產超乎國際品質的分條機、分條刀及分條機用配件。

道德企業有限公司

電話：+886-2-2995-7607

傳真：+886-2-2995-5048

郵箱：sales@slitterline.com

網址：www.slitterline.com

攤位號碼：C0318

緯冠刀具

正確的工具做效率的工作。橫向拉出鎖刀座之軸心，可輕易的讓鎖刀座做向左及向右共5個45°定位選轉。便利快速的緊固刀柄系統，可防止刀柄於水準裝夾刀具時，發生刀柄掉落現象。

緯冠刀具有限公司

電話：+886-4-2492-9135

傳真：+886-4-2492-9256

郵箱：info@wei-guan.com.tw

網址：www.wei-guan.com.tw

攤位號碼：世貿一館 1F A0121



SHINZAWA

精度的絕對值 性價比的最佳選擇

Integrity, Service, Quality and Prominence



▲SV-50S/65S/76S  
立式綜合加工中心機  
Vertical Machining Center



▲SV-50DT/65DT  
鑽銼攻牙中心機  
Drilling Tapping Center

▲S56-MT  
動柱式立式綜合加工中心機APC  
Traveling Column Vertical Machining Center



▲VB-116/127/147/168/208  
立式綜合加工中心機(硬軌)  
Vertical Machining Center (Box way)



▲SDC-8/10/12  
SDC-16/22/32  
龍門高速加工中心機  
CNC Double Column Machining Center



SV-85S/110S/130S  
SV-865S/1165S/1365S  
立式綜合加工中心機  
Vertical Machining Center

2019 TIMTOS  
Taipei Int'l Machine Tool Show  
Nangang Hall 2 P1002

震澤精密機械股份有限公司  
Shinzawa Precision Machinery Co., Ltd.

42854 台中市大雅區雅潭路三段537-1號  
TEL: +886-4-25690150 FAX: +886-4-25690165  
E-mail: info-cnc@shinzawa.com.tw



www.shinzawa.com.tw





# HYDRAULIC PRESS MAKER

## ODM & OEM In-House Design and Manufacture

SPC DEES Hydraulic, a hydraulic press manufacturer with factories in Taiwan and China since 1976, is focusing on increasing our manufacturing flexibility, constructing global distribution networks, improving quality standards and reducing manufacturing costs for clients. DEES supplies customers such as Boeing, Honda, Toyota, Audi, Volkswagon, Mercedes-Benz, Volvo, Bosch Group home appliances, Electrolux, GE home appliances, Haier, Foxconn, and more. From 10 to 6,000 ton, DEES provides more than 4,500 custom-made hydraulic presses in the world.



**Dees Hydraulic Industrial Co., Ltd.**

TEL: +886-2-2601-8661 FAX: +886-2-2601-8936

E-mail: sales@spc.com.tw

www.deesgroup.com.tw



**TIMTOS** 2019  
Mar.4-9  
27<sup>th</sup> Taipei Int'l Machine Tool Show  
**Booth No. D0401**



# Quick Die Change System

Customized Designs Available 提供客製化設計

## Features

### For Mechanical Press

- Reduced in Die Change Time.
- Reduced Stock Inventory.
- Diverse Products in Small Batches.
- Improved Productivity and Quality.
- Reduced Labor Cost.
- Improved Operation Safety.
- Shortened Delivery Time.
- Better Working Environment.

## 特點

### 沖床專用快速換模系統

- 減少換模時間
- 多種少量的生產
- 減少存貨
- 降低勞力成本
- 增加操作安全
- 達成快速產銷
- 產量與品質改革
- 改善工廠環境



**TX-Type Die Clamp Series**  
TX型系列夾模器



**TY-Type Die Clamp Series**  
TY型系列夾模器



**Power Unit**  
氣動泵組合



**Die Arm Series**  
移模臂

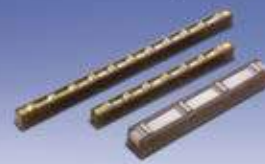

**Die Lifter Series**  
舉模器

**TIMTOS**

**2019**

**Booth No.:**

March 4-9

**D0530**

Taipei World Trade Center Exhibition Hall 1

**AGENT WANTED**

**富偉精機股份有限公司**  
FORWELL PRECISION MACHINERY CO., LTD.

T +886-4-834-5196 F +886-4-834-5197  
E forwell@forwell.com Skype: forwell

**富偉精密機械(寧波)有限公司**  
FORWELL PRECISION MACHINERY (NINGBO) CO., LTD.

T +86-574-8659-9196 F +86-574-8659-9197  
E forwell@forwellnb.com Skype: forwellnb

**富偉機械科技(淮安)有限公司**  
FORWELL MACHINERY TECH (HUAIAN) CO., LTD.

T +86-517-8565-9196 F +86-517-8565-9197  
E forwell@forwellha.com Skype: forwell.ha



Taiwan



Video Online



## 在地美味

今天想吃什麼？在台北，無論想嘗一口有媽媽味的台式家常菜、令人懷念的在地古早味，或想吃頓粵菜、江浙菜、日本料理、歐陸餐食、美式餐點、南洋風味……，豐富多樣的美食蹤跡隨處可尋，創新的佳餚更是令人驚豔，不僅滿足食客挑剔的味蕾，料理職人的堅持與用心，更為每道菜添了暖心的溫度。



脆皮烤鴨



台灣季節野菜

每個饕客的口袋裡都有台北必吃的美食名單，儘管鹹甜苦辣各有所好，這座城市各個角落端出的好味道與熱情服務，也深受米其林青睞。

2018年問世的《台北米其林指南》，粵式料理餐廳頤宮摘下米其林3星的榮耀，中式餐廳請客樓、日本料理祥雲龍吟榮獲米其林2星評鑑，入選1星的餐廳則有17間，包括台灣道地餐食金蓬萊遵古台菜及明福台菜海產、粵菜餐廳雅閣與大三元，不斷推陳出新的RAW，還有法式、歐式、日本料理等各式風味。

此外，米其林精選的36間「必比登推介」美食名單，涵蓋10間夜市小吃、5間台式餐廳、8家牛肉麵，以及江浙菜、上海菜、粵菜、北京菜和各式異國菜，是體驗台北人日常飲食的絕佳選擇。



油潑麵

小籠包

## 四季活動

台北的春、夏、秋、冬各自散發著獨有氣息，隨著四季登場的活動，讓整座城市迸發出迷人的魅力。

春日的台北無處不飛花，嬌豔的櫻花是陽明山花季的重頭戲，杜鵑花季的燦爛景致為繁華街區增添一抹恬靜，竹子湖海芋季純淨的田園美景能讓人忘卻煩憂。



杜鵑花季

時序進入溫暖夏季，台北人的休閒重心紛紛移往河濱公園，河岸音樂季、河岸童樂會、台北親水節、端午嘉年華成為全家大小的年度消暑盛事。

秋天的關渡、北投分外熱鬧，國際賞鳥博覽會、北投生態博物園區活動是親近自然的好時機，鬧熱關渡節、台北溫泉季可貼近在地人生活，關渡國際自然藝術季、白晝之夜則深獲文青喜愛。

而台北馬拉松、台北繽紛耶誕季、跨年晚會、年貨大街、台北燈節等冬季活動，不僅點燃城市活力，也為歲末年初注入繽紛色彩。



跨年晚會



馬拉松



台北親水節



台北燈節

### 旅遊諮詢及查詢

台北市民當家熱線：1999 (外縣市請撥 02-2720-8889)  
台北旅遊網：[www.travel.taipei](http://www.travel.taipei) (以中、英、日、韓、印尼、西班牙語介紹台北市各項觀光資訊，並提供景點語音導覽及旅館資料庫等服務。  
台灣旅宿網：[taiwanstay.net.tw](http://taiwanstay.net.tw) (可查詢合法旅館)  
交通部觀光局 24小時免付費旅遊諮詢：0800-011-765 · [taiwan.net.tw](http://taiwan.net.tw)  
交通部觀光局免付費旅遊申訴專線：0800-211-734  
外國人在台生活諮詢熱線：0800-024-111  
台北市政府警察局報案專線：110

### 走動式旅遊服務

每週六、日在西門町、士林、信義、北門、永康街，由走動式旅遊服務員於固定值勤路線，提供英語、日語、韓語等旅遊諮詢服務，相關資訊請至 [www.travel.taipei](http://www.travel.taipei) 查詢。

文字資料提供者：台北市政府觀光傳播局

# 只要一個步驟即可瞭解TIMTOS展覽訊息

今年您除了由榮格工業傳媒承辦的展會快報瞭解TIMTOS展會訊息之外，還可以通過**現場直播**，通過動態影片的即時報導，您可以無時無刻瞭解展會現況。

直播內容包含開幕典禮、採購洽談會、記者會、**2019高峰論壇**、學生參觀及導覽、**工業4.0智慧製造研討會**、**智慧製造聯網數據增值產業聯盟會員大會**、**2019年台北國際工具機展歡迎酒會暨工具機研究發展創新產品競賽頒獎典禮**、**2019台北國際工具機展GLORIA智慧製造創新應用論壇**以及展商採訪等等精彩內容。不論您是否在現場，都可以通過直播間，快速瞭解2019年TIMTOS的最新動態。

我們也誠摯邀請您前來榮格攤位獲取其他更多產業訊息，如金屬加工、汽車、醫療、智慧製造等。  
攤位號：**南港1館I2138**，歡迎前來交流。



掃描QR CODE立即看直播  
▲短影片更適合零碎時間觀看，提升觀看意願





Smart Management

Smart Machines

Smart Automation

與您攜手實踐工業4.0  
Realizing Your Smart Factory Dream



永進機械工業股份有限公司  
YEONG CHIN MACHINERY INDUSTRIES CO., LTD.  
TEL: 886-4-2562-3211 FAX: 886-42562-6479  
www.YCMCNC.com  sales@YCMCNC.com



27<sup>th</sup> Taipei International Machine Tool Show

Booth No. **J0618**  
March 4-9, 南港展覽館1館  
Nangang Exhibition Hall 1