



TIMTOS APP



Wechat

The official show daily of TIMTOS 2019

Total Visitor Count: 12,757 International: 4,127 Local: 8,630



## Contents

Show Updates ..... P3-5  
 Industry Updates ..... P7  
 Exhibitor Interview ..... P9-11  
 Special Report ..... P12  
 Exhibit Highlights ..... P16-19

展覽新聞 ..... P24-27  
 工業資訊 ..... P29  
 專題報導 ..... P30-31  
 參展商採訪 ..... P32-34  
 產品報導 ..... P36-38

# Taiwan Machine Tools Industry Awarding the Smart Machinery Innovators



攤位號 J0330

## 全球第三大工具機集團

World 3<sup>rd</sup> Largest Machine Tools Group

## 全球 37 大品牌 · 50 個生產基地

37 Brands and 50 Production Bases Worldwide













**FX-800**

## Smart, Exquisite And Exceptional Mechanical



**LA-250YS**



**MX-800**

Taiwan TAKISAWA Technology Co., Ltd.

+886-3-4643166

info@takisawa.com.tw

www.takisawa.com.tw







The 14<sup>th</sup> Awards Ceremony of the Taiwan Machine Tool Industry Awards for Excellence in Research Innovation honors companies and their technologies that have made outstanding contributions to innovations and development in Taiwan's machine tools industry. The ballroom was packed with executives, professionals, media, VIPs and more. All excited to know who will bag the number of awards in this year's ceremony.

Echoing TIMTOS 2019's theme: "Industry 4.0 & Smart Manufacturing," smart machinery is included as a special category in the competition to encourage innovation and development of the industry.

With the new trends in industrial manufacturing, the industry is entering into a new phase of development. Component and machine tool builders play an important role in supporting industry upgrade through enhancing supply chain efficiency.

TAITRA President & CEO Walter Yeh once said that there is a full-fledged machine tool industry supply chain in Taiwan, complete with the capability to implement robotics, sensors, Internet of Things, and Big Data applications to achieve more flexible, rapid and smarter production lines.

The academic, government and private sectors have been actively investing in the research and development of key components innovation, artificial intelligence, human-machine collaboration, system integration, and production automation", he adds.

A total of 43 entries were submitted this year reviewed by a judging panel comprising of notable committees in the field of machinery tool design and manufacturing. The competition was conducted by product categories and subcategories.

Here are the results of this year's intense competition.

## Winners of Taiwan Machine Tools Industry Award 2019 for Excellence in Research and Innovation

All CNC machine tools		
Prize	Company	Products
Supreme Excellence Award	Ching Hung Machinery & Electric Industrial Co., Ltd.	HD886L-High speed milling compound EDM
Machining Center		
Prize	Company	Products
Grand Champion Award	YEONG CHIN MACHINERY INDUSTRIES CO., LTD.	NFX800B-MPS Intelligent Multi-Axis Flexible Manufacturing System
Award of Eminence	Campro Precision Machinery Co., Ltd.	Vertical, Machining Center(NV-1280)
Award of Eminence	QUASER MACHINE TOOLS, INC.	UX500P APC 5 Axes Machine Center
Award of Eminence	SIGMA CNC Technology Machinery Co., Ltd.	CNC Double Column Five-Axis Machining Center (Heavy Cutting)-S5A-4732HH
CNC Lathe		
Prize	Company	Products
Grand Champion Award	GOODWAY MACHINE CORP.	GTW-1500 TURRET/GANG TOOLING MULTI-AXIS TURNING CENTER
Award of Eminence	L&L Machinery Industry Co., Ltd.	Smart Heavy Duty Multi-Axis Complex Machine, LLS-M
Award of Eminence	Campro Precision Machinery Co., Ltd.	CNC Turning & Milling Center NT-208SY
Other NC Machine Tools		
Prize	Company	Products
Grand Champion Award	Ching Hung Machinery & Electric Industrial Co., Ltd.	RV853L-Intelligent Linear Motor Drive Wire EDM
Award of Eminence	ACCUTEX TECHNOLOGIES CO., LTD.	AP+6040A+Wire EDM Machine
Award of Eminence	TOP WORK Industry Co., Ltd.	TP-4, 4-Axis CNC Cylindrical Grinding Machine
Award of Eminence	Excetek Technologies Co., Ltd.	NP500L 智慧化高精度線馬線切割加工機
component for CNC machine tool Other NC Machine Tools		
Prize	Company	Products
Grand Champion Award	HIWIN Technologies Corporation.	Colling Type III, R40-16K3-FDCC3
Award of Eminence	SYNTEC TECHNOLOGY CO., LTD.	Ethernet-based Open CNC Platform-SYNTEC 220MA Series Controller
Award of Eminence	HIWIN MIKROSYSTEM CORP.	CRE absolute resolver direct drive motor system TMY65D
Award of Eminence	HABOR PRECISION INC.	HIG series-DC inverter cooler HBO-N750PTSA8
Intelligent machine tools or key components for all CNC machine tools and key components		
Prize	Company	Products
Special Award	YEONG CHIN MACHINERY INDUSTRIES CO., LTD.	UX500P APC 5 Axes Machine Center
Award of Eminence	Ching Hung Machinery & Electric Industrial Co., Ltd.	RV853L-Intelligent Linear Motor Drive Wire EDM
Award of Eminence	SYNTEC TECHNOLOGY CO., LTD.	Ethernet-based Open CNC Platform-SYNTEC 220MA Series Controller
Award of Eminence	SHIEH YIH MACHINERY IND. CO., LTD.	Intelligent Manufacturing Management System

# TIMTOS 2019 EVENT / SEMINAR PROGRAM

Date	Time	Event/Seminar	Organizer	Venue	Remarks
3/4 (Mon.)	10:30	Opening Ceremony	TAITRA, TAMI	Lobby, 4F, Taipei Nangang Exhibition Center, Hall 2	By Invitation Only, Miranda Chien +886-2-27255200#2867
	8:00-17:00	Bfuture Global Launch & Products Announcement	Ching Hung Machinery & Electric Industrial Co., Ltd.	Room 402c, Taipei Nangang Exhibition Center, Hall 1	+886-4-23509188#527
	8:00-17:00	Fagor CNC & Feedback Systems Products Introduction	Fagor Automation Taiwan Co., Ltd.	Room 602, Taipei Nangang Exhibition Center, Hall 2	Samuel Wen +886-4-23851558
	13:30-16:30	TIMTOS 2019 Procurement Meetings	TAITRA	Room 504, Taipei Nangang Exhibition Center, Hall 1	Tina Ko +886-2-27255200#1573
	14:00-15:00	Press Conference, TIMTOS 2019	TAITRA TAMI	Room 403, Taipei Nangang Exhibition Center, Hall 1	Savannah Hou +886-2-23494677
	16:00-17:30	Market Briefing of Machinery Industry in Malaysia & Signing Ceremony for the Memorandum of Understanding between Penang Foundry & Engineering Industries Association (PENFEIA) and Taiwan External Trade Development Council (TAITRA)	TAITRA	Room 404, Taipei Nangang Exhibition Center, Hall 1	Melody Chen +886-2-27255200#2693
3/5 (Tue.)	8:00-17:00	Bfuture Global Launch & Products Announcement	Ching Hung Machinery & Electric Industrial Co., Ltd.	Room 402c, Taipei Nangang Exhibition Center, Hall 1	+886-4-23509188#527
	8:00-17:00	Fagor CNC & Feedback Systems Products Introduction	Fagor Automation Taiwan Co., Ltd.	Room 602, Taipei Nangang Exhibition Center, Hall 2	Samuel Wen +886-4-23851558
	8:30-12:00	Intelligent Manufacturing and Machine Tool Key Component Application Technology	Intelligent Machinery Technology Center, ITRI	Room 505a, Taipei Nangang, Exhibition Center, Hall 1	Helena Chang +886-49-2345309
	9:00-12:00	台日機械企業經貿交流會	TAMI	Room 504bc, Taipei Nangang Exhibition Center, Hall 1	+886-2-23494668
	9:00-16:00	TIMTOS 2019 SUMMIT	BOFT, MOEA	Room 101, TICC	Lilyan Kao +886-2-27255200#2679
	16:00-17:00	German Company Talk @ TIMTOS	TAITRA German Trade Office Taipei	Room 101, TICC	Suzie Cheng +886-2-7735-7524
	10:00-12:00	Renishaw's XK10 alignment laser system-new tool for machine tool assembly and alignment	Renishaw (Taiwan) Inc.	Room 402a, Taipei Nangang Exhibition Center, Hall 1	Eric Chuang +886-4-24603799
	10:30-12:00	TNC 640 高效率五軸輪廓控制器 - 高可靠度創新加工技術的優勢	HEIDENHAIN Co., Ltd. (Taiwan)	Room 403, Taipei Nangang Exhibition Center, Hall 1	Gloria Tsai +886-4-2358-8977 #1035
	13:00-15:00	NIDEC- Commander C Product Launch	Raise Precision Co., Ltd.	Conference Room 4, TWTC Exhibition Hall 1	Judy Chen +886-4-22606502
	13:00-15:00	Industry 4.0- Intelligent Manufacturing Conference/Mold intelligent production unit	Accutex Technologies Co., Ltd.	Room 402ab, Taipei Nangang Exhibition Center, Hall 1	+886-4-23599688#226
	14:00-15:00	JIMTOF 2020 Press Conference	Japan Machine Tool Builders' Association	Room 404, Taipei Nangang Exhibition Center, Hall 1	Keiko Honda +81-3-34343961
	14:30-16:30	智慧製造聯網數據加值產業聯盟會員大會	ITRI	Room 504a, Taipei Nangang Exhibition Center, Hall 1	+886-3-5916720
	15:00-16:00	臺灣機械工業同業公會與馬來西亞檳城機器廠商會簽訂合作協議	TAMI	VIP Briefing Room, 4F, Taipei Nangang Exhibition Center, Hall 1	Ryan Lin +886-2-23494694
	15:00-17:30	Litz Hitech Global Dealer Meeting and New Product Announcement	Litz Hitech Corporation	Room 401, Taipei Nangang Exhibition Center, Hall 1	Lisa Mo +886-4-26815711#246
18:30	Reception for TIMTOS 2019 and the Ceremony of Taiwan Machine Tool Industry Awards for Excellence in Research & Innovation	TMTF, TAITRA, TAMI	The Banquet Hall, 3F, Taipei Nangang Exhibition Center, Hall 1	Bonnie Tsai +886-2-23110358	
3/6 (Wed.)	8:00-17:00	Bfuture Global Launch & Products Announcement	Ching Hung Machinery & Electric Industrial Co., Ltd.	Room 402c, Taipei Nangang Exhibition Center, Hall 1	+886-4-23509188#527
	8:00-17:00	TIMTOS 2019 High School, University Students Guided Tour	TAMI	Room 500, Taipei Nangang Exhibition Center, Hall 1	+886-2-23494672
	8:00-17:00	Fagor CNC & Feedback Systems Products Introduction	Fagor Automation Taiwan Co., Ltd.	Room 602, Taipei Nangang Exhibition Center, Hall 2	Samuel Wen +886-4-23851558
	9:00-16:00	TIMTOS 2019 SUMMIT	BOFT, MOEA	Room 101, TICC	Lilyan Kao +886-2-27255200#2679
	16:00-17:00	German Company Talk @ TIMTOS	TAITRA German Trade Office Taipei	Room 101, TICC	Suzie Cheng +886-2-7735-7524
	8:00-17:00	The Trend of Industry 4.0 and Intelligent Machinery Technical Application Seminar	igus Taiwan Company Ltd. CTIMES	Room 505, Taipei Nangang Exhibition Center, Hall 1	KF Sun +886-2-25855526#225
	9:00-11:00	YCM Dealer Meeting	Yeong Chin Machinery Industries Co., Ltd.	Room 401, Taipei Nangang Exhibition Center, Hall 1	Claire Chen +886-4-25623211#1812
	10:30-12:00	選擇美國投資研討會 - 錢進美國教戰守則	AIT TAMI	Room 501, Taipei Nangang Exhibition Center, Hall 1	Jackie Hong +886-2-27201550#334
	13:00-17:00	New Product Launch	Vision Wide Tech Co., Ltd.	Room 502, Taipei Nangang Exhibition Center, Hall 1	Michelle Huang +886-4-22712000#231
	13:00-17:00	Goodway Group New Product Launch Event	Goodway Group	Room 504a, Taipei Nangang Exhibition Center, Hall 1	Lisa Chiang +886-4-24629698#62107
	13:30-16:30	Application of mineral casting (polymer composite) in machinery field	Shandong Nano Advanced Materials Technology Co., Ltd.	Room 304, Taipei Nangang Exhibition Center, Hall 1	+86-531-88917773
13:30-17:00	中國砂輪新產品發表會	KINIK COMPANY	Conference Room 2, TWTC Exhibition Hall 1	+886-2-26791931#3309	
3/7 (Thu.)	8:00-17:00	直得科技新品說明會	Chieftek Precision Co., Ltd.	Room Happiness, 3F, Taipei Nangang Exhibition Center, Hall 1	+886-6-5055858#162
	8:00-17:00	Bfuture Global Launch & Products Announcement	Ching Hung Machinery & Electric Industrial Co., Ltd.	Room 402c, Taipei Nangang Exhibition Center, Hall 1	+886-4-23509188#527
	8:00-17:00	TIMTOS 2019 High School, University Students Guided Tour	TAMI	Room 500, Taipei Nangang Exhibition Center, Hall 1	+886-2-23494672
	8:00-17:00	Fagor CNC & Feedback Systems Products Introduction	Fagor Automation Taiwan Co., Ltd.	Room 602, Taipei Nangang Exhibition Center, Hall 2	Samuel Wen +886-4-23851558
	13:30-17:00	2019 台北國際工具機展 GLORIA 智慧製造創新應用論壇	MOST, TAITRA, TAMI	Room 402ab, Taipei Nangang Exhibition Center, Hall 1	Jessica Guo +886-2-25774249#827
	14:00-16:00	Energy Saving Technology for Hydraulic System and Filtration of Cooling Lubricant	HYDAC Technology Ltd. Sterling TSI Co., Ltd.	Room 502, Taipei Nangang Exhibition Center, Hall 1	Jojo Yang 886-4-22602278
	14:00-16:00	Improving the quality and efficiency of grinding processing	Join Star Trading Co., Ltd.	Room 505b, Taipei Nangang Exhibition Center, Hall 1	Jamie Chang +886-2-29115226#607

Subject to change without notice.





Boudy is very much impressed by the good quality of Taiwanese machine tools. He has bought two Vertical Machining Centers (VMCs) in the first day. He likes that TIMTOS 2019 shows many total solutions which he finds interesting. Regarding the layout and arrangement of this show, Boudy uses “impeccable” to describe how he feels. He thinks that everything about this show is very good.

**Khaled El Boudy**  
Alex Power Technology  
Egypt



Kathryn has visited TIMTOS for four times. She says it's nice to see that Taiwan has such determined and creative engineers who want to do a lot of technologies to better the industrial manufacturing industry. Urged by digital transformation and smart technologies, Taiwan manufacturers are indeed technology driven.

**Kathryn Gerardino-Elagio**  
International Metalworking News for Asia  
Philippines



As the TIMTOS official show daily publisher, Lake from Ringier Trade Media is totally impressed by the responsible, careful and detailed working style of partner colleagues from the trade show organizers. Lake thinks this is one of the many important reasons that have made TIMTOS 2019 an unprecedented success in its history. He feels the profession everywhere at the show, from the shuttle bus, to the media center, and even to the toilet!

**Lake Shi**  
Ringier Trade Media  
China



This is Alshidiq's first time in Taiwan. Having learned about TIMTOS from Singapore, everything is 100% new to him. He is very excited to see so many Taiwanese machine tools. Alshidiq is wishing he could see all the machines shown in the show. But since there are 7,000 booths displayed in four sites, Alshidiq worries that the clock is ticking.

**Ahmed Alshidiq**  
Eastern Trade Media Pte. Ltd.  
Singapore



Cao says nothing but high praises about the show. She noticed that there are many flowers in each site which makes her feel happy every time she visits the exhibition halls. Cao also finds it easy to find the booths she wants to pay a visit. Also, she is impressed how most of the exhibitors are showing the advanced machines equipped with the latest trends, no matter how young those makers are.

**Cao SHengyu**  
Metal Working Magazine Agency  
China



With all her many experiences attending exhibitions, Elizaveta told Show Daily team that she has found a CNC machine made by a Taiwanese manufacturer, which she has never seen before. She is writing the story about this machine and the article will be printed out in her Russian Industrial Regions May 2019 issue.

**Elizaveta Voitcekhovskaia**  
Russian Industrial Regions  
Russia

## TIMTOS 2019 EVENT / SEMINAR PROGRAM

3/8 (Fri.)	8:00-17:00	直得科技新品說明會	Chieftek Precision Co., Ltd.	Room Happiness, 3F, Taipei Nangang Exhibition Center, Hall 1	+886-6-5055858#162
	8:00-17:00	Bfuture Global Launch & Products Announcement	Ching Hung Machinery & Electric Industrial Co., Ltd.	Room 402c, Taipei Nangang Exhibition Center, Hall 1	+886-4-23509188#527
	8:00-17:00	TIMTOS 2019 High School, University Students Guided Tour	TAMI	Room 500, Taipei Nangang Exhibition Center, Hall 1	+886-2-23494672
	8:00	Fagor CNC & Feedback Systems Products Introduction	Fagor Automation Taiwan Co., Ltd.	Room 602, Taipei Nangang Exhibition Center, Hall 2	Samuel Wen +886-4-23851558
	9:30-18:00	智慧製造論壇	Fusionmedium TAITRA	Conference Room 4,5, TWTC Exhibition Hall 1	Sica Lin +886-2-87715865#180
	9:30-14:00	Diplomatic Motion Solution Product Training and Conference	Diplomatic MS S.p.A Ace Pillar Co., Ltd.	Room 502, Taipei Nangang Exhibition Center, Hall 1	+886-2-29958400#1232
	10:00-17:00	中興大學與精密機械研究發展中心智慧機械產學論壇技術成果發表會	國立中興大學 & 財團法人精密機械研究發展中心	Taipei Nangang Exhibition Center, Hall 1	+886-4-22858139
3/9 (Sat.)	13:00-16:00	3D Printing+3D Scanning	Road Ahead Technologies Consultant Corp	Room 404, Taipei Nangang Exhibition Center, Hall 1	Evelyn Lin +886-2-2999-6788#284
	8:00-17:00	TIMTOS 2019 High School, University Students Guided Tour	TAMI	Room 500, Taipei Nangang Exhibition Center, Hall 1	+886-2-23494672
	8:00-17:00	Fagor CNC & Feedback Systems Products Introduction	Fagor Automation Taiwan Co., Ltd.	Room 602, Taipei Nangang Exhibition Center, Hall 2	Samuel Wen +886-4-23851558

Subject to change without notice.



新世代智能化控制 / 全方位的加工對策

# 攜手邁向智慧製造

## SMART MANUFACTURING STARTS HERE!

**AiLINC** COMING SOON

**i Console**

**G.LINC**  
**G.NET**



### GRW series

走頭式外圓磨床

Traveling Head Cylindrical Grinder



### RG5 series

天車式高速五軸加工機

High Speed Gantry Type 5-axis Machining Center



### GVF series

高剛性立式車銑複合機

Super Rigid Vertical Turning Center

**TIMTOS**

2019 台北國際工具機展

南港 1 館  
攤位號碼：

**I 0816**

**AWEA** 亞崙機電



亞崙機電股份有限公司  
AWEA MECHANTRONIC CO., LTD.  
+886-4-2462-9698 sales@awea.com  
www.AWEA.com

**GOODWAY** 程泰機械



程泰機械股份有限公司  
GOODWAY MACHINE CORP.  
+886-4-2463-6000 goodway@goodwaycnc.com  
www.GOODWAYCNC.com

**EXTRON** 益全機械



益全機械工業股份有限公司  
YIH CHUAN MACHINERY INDUSTRY CO., LTD.  
+886-4-2359-3351 sales@extroncnc.com  
www.EXTRONCNC.com



## Things to Expect at TIMTOS 2019 Summit



The fundamental dynamics of the industrial equipment manufacturing industry have changed and everyone must change along or face potential business disruptions. One can start by realizing that business has been replaced with one that requires different strategies for building manufacturing supply chains that can withstand severe headwinds.

TIMTOS is committed to fostering innovation in the industrial equipment manufacturing industry through its 2-day Summit. Here, TIMTOS aims to provide high-quality forums that create an environment conducive to interaction among technology providers and engineers creating products.

As the drumbeat for digitization grows louder, industrial manufacturers must develop new strategies for technology investments. At the Summit, attendees from different nations are invited to look, think, and talk about the latest trends, products and solutions. Every keynote and panel discussions will talk about how to obtain improved efficiency and production transparency from connected technologies and digitization.

Inspiring and noteworthy keynotes from various experts will focus on: Machine Intelligence and AIoT, Additive Manufacturing, Innovation in Aerospace Manufacturing, and the Revolution in Automotive Manufacturing.

Leonor F. M. Lin, Executive Vice President of TAITRA, comments, “This Summit is the result of our successful start in 2017, in which it was very well received. As trends reshape businesses, new technologies are emerging. The next-generation of industrial technologies encompass IoT, cloud computing, artificial intelligence, 3D printing, robotics, and advanced materials, and we are honored to have such an international speaker lineup that will help drive the future and inspire possibilities.”

Speakers included: Bernhard Meyer, SAP Global Solution Manager, Industry Business Unit, Industrial Machinery & Components (IM&C), Arthur Liu, Vice President, ITTS, Wen-Yuh Jywe, President of National Formosa University, Jay Lee, Professor at the Univ. of Cincinnati, K.C. Chuang, Honorary Chairman of TAMI, Dr. Neun Harald, COO, DMG MORI, Pascal Pierra, General Manager, Asia Pacific, Optomec, Oscar Yang, Sales Director of Great China, Road Ahead Technologies Consultant, Catherine Lu, TV Journalist, Business Nexr Media Corp., Peter Topol, Senior Product Manager, Heidenhain, Tino Hildebrand, Vice President, Siemens Ltd., Taiwan, Rémi GERMAIN, Aerospace & Defense Industry Sales Director, Dassault

Systèmes, Cyrille SCHWOB, Head of Technology, Asia-Pacific, Airbus, HT Choong, Regional Manager- Service Sales (SAS & Taiwan), ABB, Charlie Chen, Division Sales Manager of Industrial & Mobile Application, Bosch Rexroth Taiwan, and Fan-Tien Cheng, Director, Intelligent Manufacturing Research Center (IMRC), National Cheng Kung University.

“TIMTOS is now the 3<sup>rd</sup> largest machinery exhibition in the world. Thanks to President Ing-Wen Tsai for listening to my suggestion on building TaiNex 2,” says Alex Ko, Chairman of TAMI.

He adds, “We need more space for exhibition if we want to be on the top. How else can we attract more buyers in this never ending changes in the industry? But to build a bigger space for us to present our products and interest people to come and see our technologies.”

To date, Alex is happy to announce that buyers grew when compared to last year. “Several companies have revised their order volumes. I must admit that the dispute between China and the U.S. affected our order volumes but yesterday several companies have now revised their order volumes, which brings us on a positive note,” explains Alex. ■

## Closer-ties between PENFEIA and TAMI with MoU



Penang Foundry & Engineering Industries Association (PENFEIA), a non-profit trade organization which is a representative body for the foundry and engineering trade industries in the northern region of Malaysia, and Taiwan Association of Machinery Industry (TAMI), have entered into memorandum of understanding (MoU) on March 5, 2019 during the TIMTOS exhibition.

The MoU aligns both parties in developing and incorporating technology capital development programs and promoting future business in line with Industry 4.0.

Established in 1979 and a member of Federation of Malaysian Foundry & Engineering Industries Associations (FOMFEIA), PENFEIA currently consists of 50 companies, who are mainly SMIs, involved in engineering and manufacturing industries. The association

promotes the interests of the business community in Penang regarding trade and industrial relations.

PENFEIA President Richard B. C. Teh urges industry players to embrace the future of manufacturing, driven by digital revolution and the Internet of Things, in line with the global modernisation.

Working with PENFEIA is anticipated to compliment TAMI’s mission to provide leading technologies to valued customers. Now with PENFEIA’s support, TAMI President C.C. Wang believes the agreement will be beneficial as they reach customers in Malaysia.

Taiwan industries has shown that it is one of the fore runners of Industry 4.0. Therefore this creates a very big opportunity between Malaysia and Taiwan to be working hand in hand together moving towards Industry 4.0. ■

## Wire Cut EDM Automation Mold Processing Only 7 Days

The development of Taiwanese machine tools into Industrial 4.0 is getting more sophisticated. Some Taiwan makers have launched, one by one, complete systematic products. In TIMTOS 2019 “Industrial 4.0 Smart Production Seminar,” two Taiwan companies pioneered a CNC Wire Cut EDM Automation Solution which can shorten mold processing time from 30 days to only 7.

The makers point out that their wire cut EDM Automation Solution system can start mold processing with blue-print only. The system would categorize each part according to the blue-print and would

arrange their processing schedule. With the help of robot-arm, material can be taken out from warehouse automatically. And the probe measuring system would help to do the adjustment and put material into wire cut machine, completely removed manpower involvement.

Other than unmanned installation and adjustment, the most powerful function of this system is that it has a core remove module. By using flushing nozzle, it can remove the core automatically. Not only can reduce human operation and increase productivity, but also can be done during wire cut EDM machining. ■



# TIMTOS 2019 Summit

Time: 09:00-17:00, Tuesday, March 5, 2019  
Location: Room 101, TICC (No. 1, Sec. 5, Xinyi Road, Taipei)

Time: 09:00-17:00, Wednesday, March 6, 2019  
Location: Room 101, TICC (No. 1, Sec. 5, Xinyi Road, Taipei)

Session 1: Machine Intelligence and AIoT	
Time	Agenda / Speaker
09:00-09:20	Registration
09:20-09:30	Opening Remarks Leonor F. M. Lin, Executive Vice President of TAITRA Alex Ko, Chairman of TAMI
09:30-10:10	【Keynote】 How SAP helps Customers to Create Value with Industry 4.0 and Internet of Things in Discrete Industries Bernhard Meyer, SAP Global Solution Manager, Industry Business Unit, Industrial Machinery & Components (IM&C)
10:10-10:50	【Keynote】 The Intelligent IoT Asset Management Platform for Smart Factory Arthur Liu, Vice President, ITTS
10:50-11:30	【Keynote】 Realization of Taiwan Industrial Internet of Things Application from Industry-University Cooperation Wen-Yuh Jywe, President of National Formosa University
11:30-12:10	【Keynote】 Trends of Industrial AI and Industrial Internet Jay Lee, Professor at the University of Cincinnati
12:10-12:30	【Panel Discussion】 The Future of Work Moderator: K.C. Chuang, Honorary Chairman of TAMI Panelists: All Speakers
Session 2: Additive Manufacturing	
Time	Agenda / Speaker
13:00-13:30	Registration
13:30-14:10	【Keynote】 Advanced Machining Solutions for the Future of Manufacturing Dr. Neun Harald, COO, DMG MORI
14:10-14:50	【Keynote】 The Evolution of Metal Additive Manufacturing: Leveraging the Machine Tool Infrastructure Pascal Pierra, Director of Asia-Pacific, Optomec
14:50-15:20	【Keynote】 Making Production Real Oscar Yang, Sales Director of Great China, Road Ahead Technologies Consultant
15:20-16:00	【Panel Discussion】 Metal Additive Manufacturing - Now & Future Moderator: Catherine Lu, TV Journalist focused on Global Technology
16:00-17:00	【Side Event】 German Company Talk @ TIMTOS

Session 3: Innovation in Aerospace Manufacturing	
Time	Agenda / Speaker
09:00-09:30	Registration
09:20-10:00	【Keynote】 Master highly dynamic machining strategies with innovative solutions in the field of drive and control technology Peter Topol, Senior Product Manager, Heidenhain
10:00-10:40	【Keynote】 Embracing Industry 4.0 and Transform towards a Digital Future with Siemens Tino Hildebrand, Vice President, Siemens Ltd., Taiwan
10:40-11:20	【Keynote】 The role of the digital collaboration and innovation in the renaissance of the Aerospace Manufacturing Rémi GERMAIN, Aerospace & Defense Industry Sales Director, Dassault Systèmes
11:20-12:00	【Keynote】 Advanced manufacturing technologies Cyrille SCHWOB, Head of Technology, Asia-Pacific, Airbus
12:00-12:30	【Panel Discussion】 Transforming Manufacturing - what can we see in the next 5 years Moderator: Jwu-Sheng Hu, Vice President and General Director, Mechanical and Mechatronics Systems Research Laboratories, ITRI Panelists: All Speakers
Session 4: Automotive Manufacturing Revolution	
Time	Agenda / Speaker
13:00-13:30	Registration
13:30-14:10	【Keynote】 The Technology and Application of Industrial Robotics to New Era of Smart Manufacturing HT Choong, Regional Manager- Service Sales (SAS & Taiwan), ABB
14:10-14:50	【Keynote】 CNC Systems for Factory of the Future Charlie Chen, Division Manager of Industrial & Mobile Application, Bosch Rexroth Taiwan
14:50-15:20	【Keynote】 Intelligent Factory Automation (iFA) for Industry 4.1 Fan-Tien Cheng, Director, Intelligent Manufacturing Research Center, National Cheng Kung University
15:20-16:00	【Panel Discussion】 The Revolution is Speeding Up - Are We Ready? Moderator: Jwu-Sheng Hu, Vice President and General Director, Mechanical and Mechatronics Systems Research Laboratories, ITRI Panelists: All Speakers
16:00-17:00	【Side Event】 German Company Talk @ TIMTOS

\*Topics are subject to change and will be updated anytime.  
\*Chinese/English onsite simultaneous interpretation provided.

## Speakers / Moderators

<p><b>Bernhard Meyer</b> SAP Global Solution Manager, Industry Business Unit, Industrial Machinery &amp; Components (IM&amp;C)</p> 	<p><b>Dr. Neun Harald</b> COO, DMG MORI</p> 	<p><b>Peter Topol</b> Senior Product Manager, Heidenhain</p> 	<p><b>Jwu-Sheng Hu</b> Vice President and General Director, Mechanical and Mechatronics Systems Research Laboratories, ITRI</p> 
<p><b>Arthur Liu</b> Vice President, ITTS</p> 	<p><b>Pascal Pierra</b> Director of Asia-Pacific, Optomec</p> 	<p><b>Tino Hildebrand</b> Vice President, Siemens Ltd., Taiwan</p> 	<p><b>HT Choong</b> Regional Manager- Service Sales (SAS &amp; Taiwan), ABB</p> 
<p><b>Wen-Yuh Jywe</b> President, National Formosa University</p> 	<p><b>Oscar Yang</b> Sales Director of Great China, Road Ahead Technologies Consultant</p> 	<p><b>Rémi GERMAIN</b> Aerospace &amp; Defense Industry Sales Director, Dassault Systèmes</p> 	<p><b>Charlie Chen</b> Division Manager of Industrial &amp; Mobile Application, Bosch Rexroth Taiwan</p> 
<p><b>Jay Lee</b> Professor, University of Cincinnati</p> 	<p><b>Catherine Lu</b> TV Journalist Business Next Media Corp</p> 	<p><b>Cyrille SCHWOB</b> Head of Technology, Asia-Pacific, Airbus</p> 	<p><b>Fan-Tien Cheng</b> Director, Intelligent Manufacturing Research Center, National Cheng Kung University</p> 
<p><b>K.C. Chuang</b> Honorary Chairman of TAMI</p> 			



## Industrial Metrology Market Worth US\$12.97 Billion by 2023

According to the new market research report by Markets and Markets, the industrial metrology market, the market is expected to grow from US\$9.62 billion in 2018 to US\$ 12.97 billion by 2023, at a CAGR of 6.2% during the forecast period.

The growing big data analytics market and increasing demand for inspection services from precision manufacturing drive the growth of industrial metrology market. Moreover, increasing focus on quality control in various industries also contributes to the growth of this market.

The major driver for the growth of the industrial metrology market for hardware is the increasing adoption of industrial metrology products in the industries such as aerospace and defense, and automotive to maintain product quality. Furthermore, the use of 2D metrology products for dimensioning and inspection applications also contributes to the growth of the market for hardware.

The rising need for precision

dimensional analysis and validation of geometric accuracy in the manufacturing, automotive, aerospace, and military industries contribute to the largest share of coordinate measuring machines (CMMs) in the market based on equipment.

Industries such as automotive and aerospace face increasing demand for intense quality control and inspection; not meeting quality standards can hamper their reputation and, ultimately, their brand and business. Thus, these industries are prominently adopting industrial metrology for the quality control and inspection application.

The shift in preference from off-line quality inspection to near-line or in-line measurement techniques, enabling higher sampling rates and shorter inspection times in automotive sector, drives the growth of the industrial metrology market for the automotive industry. Additionally, the growing demand for automobiles in developing countries, such as India and

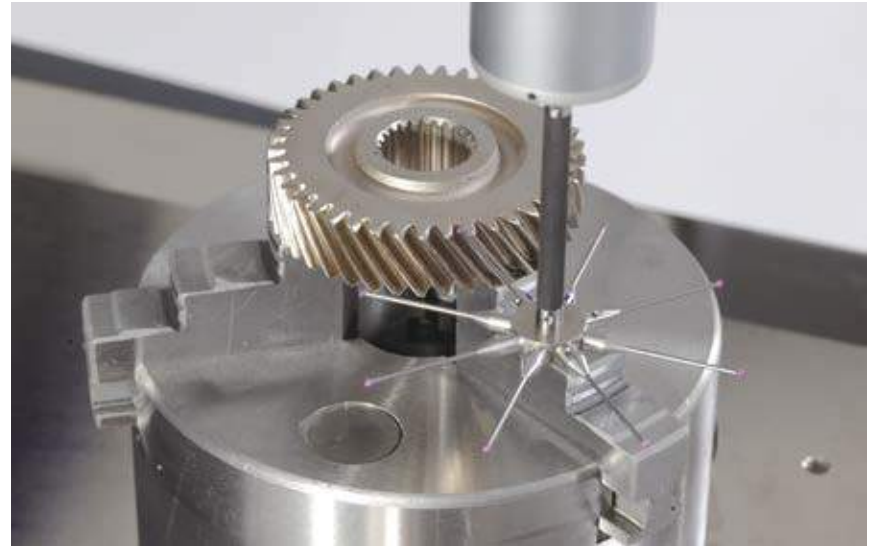

China, is expected to fuel the growth of industrial metrology market in the near future.

Highest CAGR of the market in APAC is attributed to the high economic growth of the major countries, such as China and Japan, in this region. China has a huge potential in terms of the applications of

industrial metrology offerings. Moreover, with the initiatives taken by the Government of India to encourage local and foreign players to have a manufacturing set-up in India is likely to boost the industrialisation, thereby making it an attractive market for industrial metrology. ■

Source: Int'l Metalworking News for Asia



## Rising Adoption of Automation Drives Welding Equipment Growth

Technavio market research analysts forecast the global welding equipment market to grow at a CAGR of almost 5% during 2018-2022.

The rise in adoption of automated solutions for welding is one of the major trends witnessed in the global welding equipment market 2018-2022. The use of automation in the welding process has been increasing substantially due to the rising awareness regarding automation among vendors as they are seeking to gain a competitive advantage through automation. Advancements in robotics technology have also led to the use of robots in welding processes.

According to Technavio analysts, one of the key factors contributing to the

growth of the global welding equipment market is the emergence of friction stir welding technology in the automotive sector. The friction stir welding process offers substantial advantages such as the ability to handle variations in the production process, improved mechanical properties, and low operating cost when compared with other welding processes. Automotive manufacturers can spot-weld thin aluminium sheets with friction stir welding.

APAC held the largest share of the market in 2017, accounting for close to 47% share. It was followed by the Americas and EMEA respectively. APAC is expected to dominate the market throughout the period 2018-2022. ■

Source: Int'l Metalworking News for Asia

## Metalworking Fluids Market to hit US\$14.54 Billion by 2025

The global metalworking fluids market size is projected to reach USD 14.54 billion by 2025, as per the findings of Grand View Research, Inc., progressing at a CAGR of 4.4% during the forecast period. The market is poised to witness an upsurge in the use of metalworking fluids (MWFs) in heavy machinery and automotive applications owing to growing production of sophisticated machines and components. The market is characterized by competitive pricing strategies due to increasing number of medium- and small-scale suppliers.

Demand for synthetic fluids is anticipated to experience sharp rise owing to their superior properties such as excellent surface finishing and increased tool life. Mineral-based oil is a traditionally used MWF and accounted for a volume share of 46.13% in 2017. It can

be produced in large quantities owing to abundant availability, easy accessibility, and cost-effectiveness.

Bio-based metalworking fluids are likely to witness steady growth in Europe on account of presence of stringent government legislation. For instance, REACH, a European legislation, requires MWF manufacturers to substitute harmful chemicals such as boron, formaldehyde, and chlorinated paraffins with environment-friendly alternatives. In order to comply with the European legislation norms, manufacturers are focused on producing MWFs that are free of boron, formaldehyde, and short- & medium-chain chlorinated paraffins. However, high cost of bio-based products can pose a challenge to industry growth during the forecast period. ■

Source: Int'l Metalworking News for Asia





# ASIA'S ONLY PROFESSIONAL 5-AXIS MACHINE CENTER MANUFACTURER



KEN CNC is the only company that specializes in 5 axis gantry machine centers for the aerospace and automotive industries.

We integrate European key components with Taiwanese professional team, to satisfy the needs of following industries

-  **Aircraft Industry**
-  **Automotive Industry**
-  **General Machining Industry**

## HIGH SPEED

**FEEDRATE:60 M/MIN**

## HIGH TORQUE

**MAX. TORQUE : 1,200 NM**



### FocusS

#### 5-Axis Double Column Machine Center

- High rigidity one piece column and crossbeam structure
- X/Y - axis linear motor drive
- Direct-drive motor two-axis milling head



### SABER

#### Double Column 5-Axis Machining Center

- European high torque 2-axis milling head with high torque spindle
- High rigidity one-piece base and column
- Z-axis movement by two high rigidity box-way
- Suitable for high titanium materials of aerospace industry



### COMPACTB

#### Gantry Type High Speed 5-axis Machine Center

- Gantry type
- Box-in-Box symmetrical design
- Column and base one piece design
- X/Y - axis linear motor drive
- Direct-drive motor two-axis milling head



### TITAN

#### Double Column 5-Axis Machining Center

- Z-axis moving crossbeam
- One-piece h-type column structure
- European imported high torque 2 axis milling head
- Heavy duty roller type linear guideway
- Suitable for high titanium materials of aerospace industry



### LinMAXB

#### Gantry Type High Speed 5-axis Machine Center

- Gantry type
- Box-in-Box symmetrical design
- Column one piece design
- X/Y - axis linear motor drive
- Direct-drive motor two-axis milling head
- Modular design milling head



### RHINO

#### Horizontal 5-Axis Machining Center

- Cross beam moves up and down, milling optimal rigidity
- One piece H type column
- Hydrostatic rotary table
- Short throat depth tilting milling head





# Taiwan TAKISAWA: The Mechanical Combination of Excellence and Intelligence

Set to celebrate its 50th anniversary in a few years, Taiwan TAKISAWA has thrived across the globe with its unique technologies and ancient philosophy in craftsmanship. For almost five decades, Taiwan TAKISAWA has reinforced its presence in the APAC region, USA, Europe and South East Asia (SEA). Its annual revenue topped by US\$1.1 billion; and is expected to particularly grow in the U.S. and SEA markets in the coming years.

The company will showcase their latest innovation in turning and milling machines.

## What are the main exhibits at TIMTOS 2019?

Taiwan TAKISAWA exhibits twin spindle and twin turret complex turning and Milling Machine including a series of new generation turn-mill multi-purpose machine tools LX-2500M, EX-2000YS, and VTL-750 vertical lathe.

The new generation of twin-spindle turning and milling machine adopts horizontal bed surface and 45-degree column. On the basis of high-rigidity structure, the left and right turrets can be freely equipped with Y-axis milling cutter function, with a maximum of 30 tool positions. It can be combined with a built-in robot or a door-type robot to achieve a machine that is a production line. The customer's smallest footprint and most economical, production is beyond the imagination of the heart-shaped processing benefits.

## Multi-purpose machine tools will become the new norm for manufacturers

According to Taiwan TAKISAWA, multi-tasking and multi-axis CNC lathes will become the next star equipment in the metalworking industry. Over the years, TAKISAWA has already accumulated strong experiences in the technology of multi-tasking centers.

They are now ready to occupy global clients' shop floor and work practically in every factory that aims for sustainable production. The equipment: LX-2500M and EX-2000YS have increased the speed of machining by reducing up to 50% time needed in axis movement, strengthened the structural design and increased the user friendliness by enlarging the machining ranges of the multi-tasking machines.

When asked about the future development, TAKISAWA emphasizes on intelligent manufacturing execution system (TiMES). Through the TAKISAWA intelligent manufacturing execution system, the company has greater connection inside the factory with their employees, and simultaneously, a visualized production control to meet differing demands of international clients' d. The system is an independent development that coordinates the entire production progresses, as well as quality inspection. The system is the safety net for TAKISAWA in reaching high quality

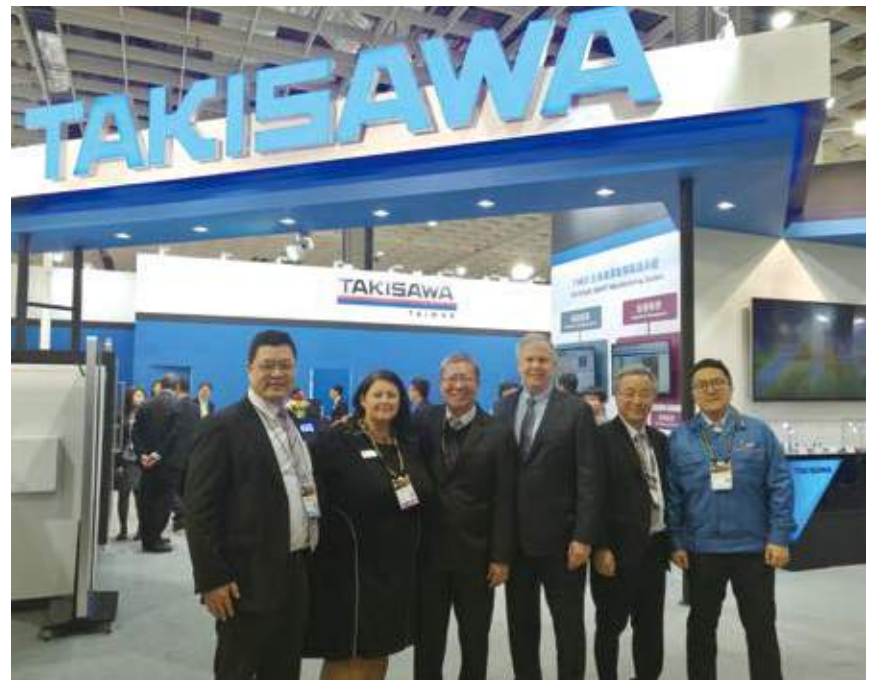

machine tools and services. The company has digitalized every process to maintain a transparent factory for each detail to be traced and optimized, including the storage in the factory, the progress on orders, and eventually solve the issue of long preparation before manufacturing.

As innovation engines TAKISAWA's mechanical technology, the company also leaps in management – Taiwan TAKISAWA adopts intelligent production and management system to regulate and moderate production, quality control and delivery. No single details could mistakenly slip out from TAKISAWA's connected smart factory.

In the future, TAKISAWA's development plans in mechanical focus would be in "modular designs" of machine tools. Here marked that this design would allow greater flexibility for machine tools to be involved in more innovative applications. The company is moving towards faster, smarter and more user friendly features for machine tools.

**Taiwan Takisawa Technology Co., Ltd.**

Tel : +886-3-4643-166

Fax : +886-3-4643-674

Website: [www.takisawa.com.tw](http://www.takisawa.com.tw)

**Booth No.: K0108**

# Marposs: A World Leader in Measurement Technology

The company was established in Bologna in 1952 by Mr. Mario Possati (1922-1990). He had the idea of making the first in-process equipment for checking parts during grinding, allowing improvements in the quality and quantity of parts made by machine tools.

The starting point of the penetration into the Asian market, started with China and Korea in the mid-80s. Marposs is

now present directly with its own sales and service organization in more than 20 countries and has a network of agents and distributors in a dozen countries.

Today, Marposs has become a world leader in measurement technology and it can supply products ranging from an individual gauging component to turnkey machines or fully automated lines: all what is needed for production improvement and quality control

in the workshop.

Marposs' mission is to provide precision metrology equipment for use in the workshop environment during and after machining operations. The equipment is designed and built for a wide range of in-process and post-process applications and for guaranteed performance in even the harshest shop floor conditions.

Constant growth is for sure one of the strategic objectives of our Group. Marposs has based its own growth on investments in innovations and new products, which might occur both through organic internal growth and through acquisitions.

After the year 2000, Marposs began a program of solid acquisitions of well-structured companies. Each able to supply top-quality product in its field (i.e. monitoring solutions, assembly and testing). All these companies were leaders in their fields, but operated within local areas; joining Marposs group, they take a great benefit from the worldwide presence of

Marposs.

On the other hand, thanks to these acquisitions, Marposs expands its range of products and solutions. The whole group has today more than 3,500 direct employees. Among them around 1,300 work at the Italian headquarters and around 800 work in China.

The past success and future development of Marposs are both based on the following principles that Marposs always applies - be everywhere the customer works to give the best support at the moment of sales and after sales, produce the most suitable solutions and continuously invest in research and development, fight for improving the customer's satisfaction, as a measure of the quality of the work done.

**Marposs Co., Ltd.**

Tel : +886-4-2262-2340

Fax : +886-4-2262-2402

E-mail: [sales@tw.marposs.com](mailto:sales@tw.marposs.com)

Website: [www.marposs.com](http://www.marposs.com)

**Booth No.: P0320**







## Every Spindle is tested up to **72 Hours**

Using state of the art instruments . Precision assembly techniques must pass High-Reliability test. The most advanced machinery finishing equipment feature-ing the best of western technology and own decades of finishing and manufacturing experience.



## CUSTOMIZATION

Help you improve the performance of processing equipment best companion.

## SPINDLES REPAIR

Provide a variety of domestic and foreign machine tool spindle service.



CNC Machining  
Center Spindle



CNC Turning  
Center Spindle



CNC Grinding  
Spindle



Special Machine  
Spindle



**KENTURN**

**ECIO**

ECIO易上手 好用好上手  
The ideal option for efficient cutting

**T** +886-4-7910-688

**F** +886-4-7910-272

**E** ecio@kenturn.com.tw

**W** www.kenturn.com.tw

難切削材刀具 / 客製特殊刀具



### Kenturn Nano. Tec. Co., Ltd

☎ +886-4-791-0271    📠 +886-4-791-0272

✉ cnc-spindle@kenturn.com.tw

🌐 www.kenturn.com.tw

📍 16E.7Rd., Chang Bin Ind. Park, Shian shi, 50741 Chang Hua, Taiwan





## FFG: Satisfying Demands of Intelligent Production Equipment

As the world's third largest machine tool group, FFG exhibits a series of products at TIMTOS exhibition in order to meet various industries and users' demands of intelligent production equipment, including 5-Axis Vertical Machining Center UB-660.

According to Mr. Andy Hung, Sales Director of FFG, 5-Axis Vertical Machining Center UB-660 is mainly positioned in aviation industry, automobile industry, energy industry, precision mold industry and other markets, with the following characteristics:

1) T-shaped ultra-high rigidity base, combined with mobile column structure, excellent dynamic performance and high precision machining in large and heavy workpieces.



2) The Swiveling type (B-axis spindle) combines with the horizontal rotary table (C-axis), and the workpiece has no rollover effect, which ensures the precision and quality of the workpiece.

3) High torque built-in type spindle, 12000rpm, torque 88.3Nm, power 37Kw.

4) Suitable for long and complex workpieces with maximize processing efficiency and minimum space.

5) Combined typed work table helps to complete the setup quickly with only one clamp, which improves efficiency and saves processing time.

6) The oil cooling system uses variable-frequency type liquid cooler to provide the spindle/ swiveling spindle head/turning table to maintain stable operation at the optimum temperature, showing high efficiency and high precision machining characteristics.

7) 5-Axis vertical machining center with high rigidity and high precision.

Over the years, Fair Friend FEELER Machine Tool has earned a world-class reputation for product excellence and reliability. This success is the result of their innovative design, in-house machining capabilities, and rigorous quality control.



In order to manufacture machines that fully meet customers' requirements all around the world, they utilize an advanced and integrated manufacturing system. "At the core of Fair Friend's manufacturing capabilities are our state-of-the-art production facilities," Andy said.

"FEELER focuses on the information feedback from customers and dealers worldwide. Through this constant feedback, R&D staffs develop and improve new

products based on market information and our experience. FEELER keeps material inspection and check at each manufacturing stage to produce the most reliable products in the market." Andy added.

**Fair Friend Ent. Co., Ltd.**

Tel: +886-4-2359-4075

Fax: +886-4-2359-4873

E-mail: [sales@feeler.com](mailto:sales@feeler.com)

Website: [www.feeler.com](http://www.feeler.com)

**Booth No.: J0330**

## Forwell: Automation Quick Die Change System Uses Revolutionary New Technology

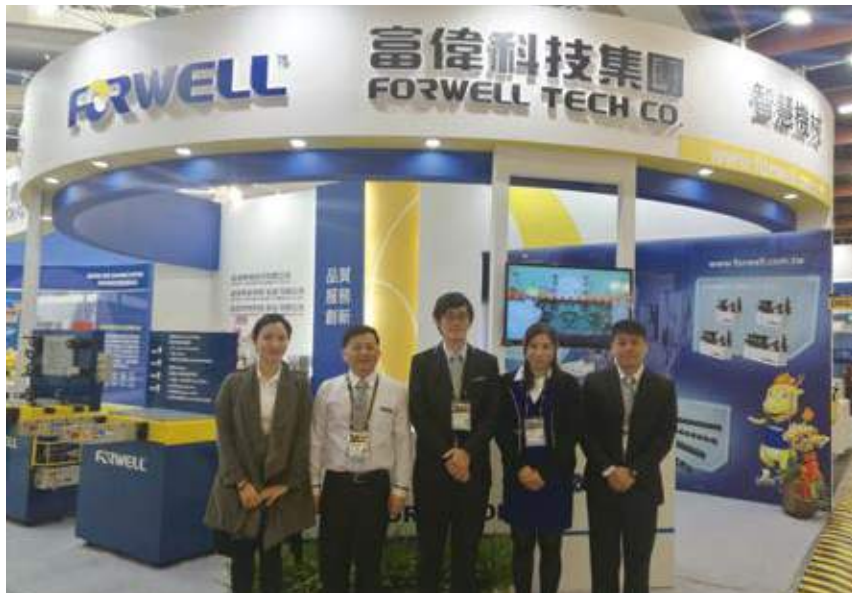

Forwell quick die change system includes die clamps, die lifters, die arms, control box and power units. Reducing die change time, saving labor costs and increasing safety are the advantages.

The quick die change system is controlled by hydraulic. It's easy and safe comparing traditional way. Although power is off, the system can keep working for 48 hours. The system is not only safe for workers but ensuring the machine operation without stopping. Forwell is a well-known manufacturer of quick die change system. High quality and best service is Forwell's

central spirit.

Forwell gradually consolidated its capacity over the years and now owns factory in Jiangsu and Ningbo. The quick die change system, quick mold change System, Die / Mold Cart System, PCB Fine Piercing System have gained their reputation, and become one of the top figures of Asain automation systems.

Forwell's quick die changing system can be applied in hydraulic or mechanical presses, plastic injection molding machines and die casting machines – its versatility is shown on the tailored ability on systematic

designs – allowing a reduction of time in production while simultaneously increase the variety of production and step into the category of small batch highly diverse production without increase in labor. The level of development of Forwell's technology is competent to link customers' entire production line with automated equipment in terms of those who aim for maximum efficiency, creativity and quality on their factory floor.

At TIMTOS 2019, Forwell will exhibit upgraded quick die change system and TD series die clamps. This optimized series are to response to the diversifying trend in the metal cutting industry. The new system can be accustomed to the production line of machine tools. It will completely eradicate the need of manual changing of molds on machine tools, which decreases downtime and allow the production line in preparing the next batch of working pieces before the previous one ends. This sort of technology is

revolutionary and still rare in the world, Forwell expects that the technology would practically help clients in the metal cutting field, a step forward to the company's main applications in metal forming.

Forwell is refining its quality with strong investment in new products and provide the most satisfying experience regarding after-sales. At TIMTOS 2019, the company focuses on providing the industry with automation technology. You are invited to visit their booth. For the next few decades, we can expect to witness more groundbreaking creation and automation systems. from Forwell. They have certainly created. unique style of harmonizing automation in the new age of mechanical equipment.

**Forwell Precision Machinery Co., Ltd.**

Tel: +886-4-8345-196

Fax: +886-4-8345-197

E-mail: [forwell@forwell.com](mailto:forwell@forwell.com)

Website: [www.forwell.com](http://www.forwell.com)

**Booth No.: D0530**

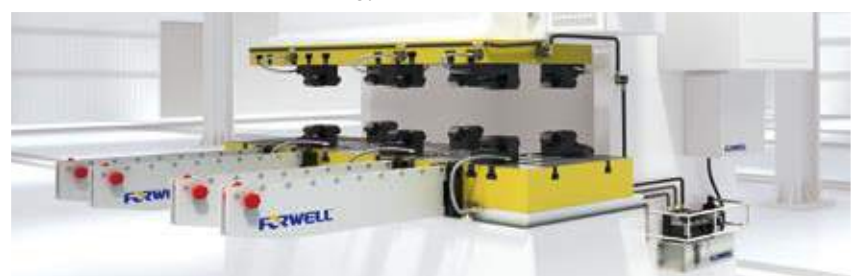



# Cutting-edge Sheet Metal Processing Trends

**A** multifunctional laser processing head plays a major role in the new NRW project MultiPROmobil; it enables innovative sheet metal assemblies through the integrated cutting, welding and manufacture of structures additively.

The Fraunhofer Institute for Laser Technology ILT from Aachen presents five groundbreaking developments on all major trends in contemporary sheet metal processing – from hybrid lightweight construction to multifunctional laser robots with an integrated digital twin.

There is a common denominator for all five processes: They stand for different approaches to agile, laser-based manufacturing, and balance flexibility and productivity. Such manufacturing processes are particularly in demand for hybrid lightweight construction and electromobility, two major trends in sheet metal working. "Laser technology combined with digitalisation is a predestined solution for economically producing constantly fluctuating and unpredictable lot sizes in volatile markets", explains Dr. Dirk Petring, group leader for Macro Joining and Cutting at Fraunhofer ILT.

## Clever interplay of robot and laser processing head

The lighthouse project MultiPROmobil fits in with this need: The NRW-funded project is a robot and a multifunctional laser processing head designed to enable clever interaction and integrate cutting, welding and generating of structures additively. They are to be supported by a digital twin as well as intelligent design and simulation software.

With MultiPROmobil, the Fraunhofer experts and their industrial partners want to reduce commissioning time by 30% and unit costs and resource consumption by at least 20%.

"In a subsequent expansion phase, a production facility with several robots were built, in which each individual robot masters all three production disciplines", says Dr. Petring, looking into the future. "In this way, process chains for the production of sheet metal assemblies can be made very flexible and scalable, especially with regard to the gradual introduction of e-mobility". Currently, the project participants are working on further developing the combi-head so that it can be changed between cutting, welding and now additive manufacturing processes as needed and without changing the optics and nozzles.

## Laser beam high-speed cutting supersedes punching process

Another highlight of the Aachen scientists at EuroBLECH is the flexible high-speed cutting of metal strips: With assistance from Fraunhofer ILT, Honda has replaced the previous punching process – of sheet metal of up to 1.8m by 4m and a thickness of 0.5 to 2.3mm – by an extremely fast laser cutting process, with a speed of up to 11 m/min at its plant in Yorii, Japan. Honda has achieved an output of 18,700 car body parts per day since introducing the laser blanking system in 2015.

Instead of punching: Together with BILSTEIN GmbH & Co. KG, Fraunhofer ILT has developed a very fast cutting process

for differentiated rolled strip with partially different properties.

Dr. Petring says, "At the fair in Hanover, reported on the next step towards a very fast cutting process for differentiated rolled strips with partially different properties; we are currently developing this process together with BILSTEIN GmbH & Co. KG in Hagen, Germany. Decisive arguments for BILSTEIN are the tool-free production of variable cutting contours and maximum material savings in the manufacturing process as well as in terms of the subsequent component weight. Not only did we show a video about the process, but also first shaped blanks made using our process".

## Joining ultra high-strength steels reliably

The lightweight construction trend towards ultra highstrength steels is the focus of a project funded by the German Federation of Industrial Research Associations (AiF), which is supported by FOSTA (Forschungsvereinigung Stahlanwendung e.V.): Within the scope of FAAM (short for Further development, joining technology validation and technical design of welded joints with martensitic chromium steels), Fraunhofer ILT and its partners are developing and testing laser welding processes on various components. The demonstrator, for example, is a laser-designed bumper module, which the Aachen scientists demonstrated how different high- and ultra-high-strength materials can be laserwelded in a hybrid construction.

## Freeform mirror creates suitable laser beam

The optimal spatial and temporal adjustment of the temperature field plays the main role in the current research in the field of laser heat treatment. In Hanover, Fraunhofer ILT showed how, by adapting the beam profile with the aid of a freeform mirror, areas and zones can be selectively and locally processed in order to generate defined strength profiles. In order to make laser heat treatment reliable and cost-effective with short cycle times, the Aachen scientists are working with significantly higher feed rates.

## Process time and costs for raw materials lowered

The fifth exhibit, a roof bow created as part of the BMBF project HyBriLight, received the "Future of Composites in Transportation 2018 Innovation Award" in Chicago in June 2018 at a JEC event. An original part of a vehicle from the BMW 7 Series was used as a model: a hybrid component with a fiber-reinforced plastic cross member (previously pure CFRP) and metallic connecting elements to the car body. As an alternative to bonding and riveting previously used, the Aachen scientists use a laser-based joining process that connects plastic and metal with positive locking and adhesion.

Moreover, material costs were significantly reduced by using GFRP instead of the more expensive CFRP. The latter is now used only as a strength-enhancing insert on the long sides of the cross member. The roof bow is finally trimmed with an innovative laser cutting process, which allows processing of the material sandwich made of GFRP and CFRP in a single step. Several advantages speak in favour of innovation reduction of process times by 70 percent compared to conventional processes, halving of raw material costs and the integration of several process steps into one process.

"In Hannover, we showed the new roof bow version, whose material mix of GFRP, CFRP and metal demonstrates the versatility of laser processing for joining and cutting complex components", reports Dr. Frank Schneider, senior project manager in the group of Macro Joining and Cutting at Fraunhofer ILT. ■

Source: Int'l Metalworking News for Asia

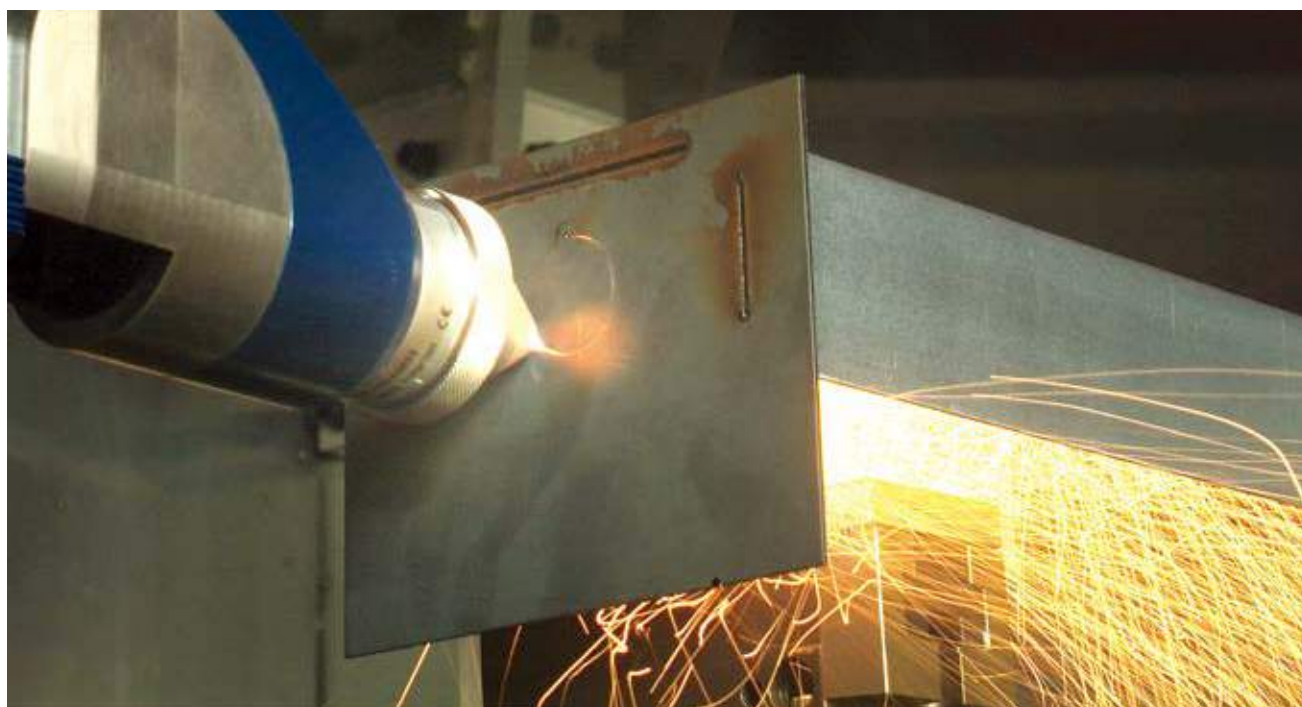





# 盈錫積極邁入智慧製造

## 生產模式滿足客戶少量多樣的需求

盈錫為國內知名的工具機零配件精密螺帽製造商，全力建構智慧化工廠，讓產品更加滿足客戶需求。



專利號  
I262262  
I385314  
I427279



YS

YSPL

歐美日等工具機大廠 ▶ 精密螺帽及精密零件主要供應商

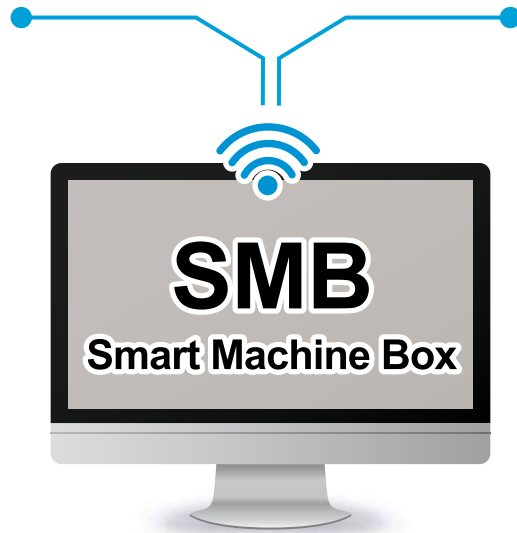

**戰情室**  
電子互動資訊看板

**Robot + AGV**  
智能化機電整合應用

**MES**

**ERP**

**AI** 智慧圖面報價  
輔助系統

**TIMTOS** 南港2館  
2019 March 4-9  
第27屆台北國際工具機展覽會  
R0814



盈錫精密工業股份有限公司 YINSH PRECISION INDUSTRIAL CO., LTD.

www.yinsh.com  
www.yinsh.hdv.tw

電話：+886-4-2244-7899  
傳真：+886-4-2245-2402

信箱：service@yinsh.com  
地址：台灣台中市北屯區崇德六路一段31巷26號





# 2019 RINGIER MANUFACTURING AND PROCESSING INDUSTRY SUMMIT

## CHINA MARKET

- ◆ High-efficiency Machining Intelligent Automation Summit 2019 | 06-07 MAR, Chongqing
- ◆ Foshan High-efficiency Processing Manufacturing Technology Summit 2019 | 11 APR, Foshan
- ◆ High-efficiency Machining Conference 2019 - Beijing | 14-15 APR, Beijing
- ◆ Difficult Processing Materials High-efficiency Processing Manufacturing Technology Forum 2019 (customized Conference) | 15 APR, Beijing
- ◆ High-efficiency Machining Conference 2019 - Nanjing | 22 MAY, Nanjing
- ◆ The Mold Technology (Ningbo) Forum 2019 | 30 MAY, Shanghai
- ◆ 2019 Global Laser Processing Technology Summit | 06 JUN, Shanghai
- ◆ The 6th Mould High Efficiency Manufacturing Technology Summit 2019(semi-customized Conference) | 10-11 JUN, Shanghai
- ◆ Global Smart Factory Summit 2019 | 28 JUN, Shanghai
- ◆ Implantable & Interventional Medical Device Manufacturing & Technology Conference 2019 | 8-9, AUG, Suzhou
- ◆ The 2nd New Energy Vehicle Manufacturing Conference 2019 | 04-05 SEP, Shanghai
- ◆ China International Internal Combustion Engine Advanced Manufacturing Technology Summit 2019 | 06 SEP, Suzhou
- ◆ China International Internal Combustion Engine Advanced Manufacturing Technology Summit 2019 | 17-18, OCT, Suzhou
- ◆ 2019 China Intelligent Laser Manufacturing Technology Forum | 24 OCT, Shenzhen



## S.E. ASIA MARKET

- ◆ ASEAN Automotive & Motorcycle Parts Manufacturing Summit | 02-03 APR, Hanoi Vietnam
- ◆ India Automotive & Motorcycle Parts Manufacturing Summit | 16-17 JUL, Pune India
- ◆ ASIA Plastics Processing Technology and Innovative Materials Summit 2019 | 29-30 AUG, Jakarta Indonesia
- ◆ ASEAN Automotive & Motorcycle Parts Manufacturing Summit | 05-06 NOV, Jakarta Indonesia



Registration, sponsorship consultation and details Information request, please scan the QR code

 **Ringier Events**  
Connecting industry through information exchange!

[www.ringierevents.com](http://www.ringierevents.com)



# 緊盯著您的刀具



 **midia**

ULTRA PRECISION PROBING

當今日對於精確的需求已達到極限之時, **Marposs Diamond System** 創新突破重新定義機上工件量測規則。

**WRP60P Diamond** 測頭提供大型機台,五軸機台以及加工中心機完善的工件檢測,確保工件,刀具的高品質及減少不良品的產生。



**MARPOSS**

您全球的合作夥伴

[www.marposs.com](http://www.marposs.com)

**馬波斯精密股份有限公司**

台中市南區復興路二段120-3號4樓

Tel. +886-4-2262-2340 Fax. +886-4-2262-2402



## Exhibit Highlights

### TK Series

Gear box for steel\paper\crane\transmission industry application

Features :

1. High strengthen tenacity & compact structure, safety coefficient up to 2.5 or more.

2. Special 25 degree pressure angle tooth profile can bear more overload & impact.

3. Carburization treatment, high precision grinding to enhance engagement rate & low noise below 80dB & increase working efficiency to extend machine life.



#### TIEN YI Gear Works Co., Ltd.

Tel: +886-3-5970-206

Fax: +886-3-5970-210

E-mail: sales122@tienyigear.com.tw

Website: www.tienyigear.com.tw

Booth No.: G0231

### Eco Servo Press

Through LCH exclusive hydraulic system, parts can be formed with high precision and control for diverse applications including metal stamping, composite compound forming such as SMC, BMC, GMT, CFRP and many more.

Features:

1. Precision servo motor system
2. Enhance pressing productivity
3. Energy efficient



4. Noise Reduction

#### LIEN CHIEH Hydraulic Industrial Co., Ltd.

Tel: +886-2-8648-3000

Fax: +886-2-8648-2000

E-mail: michael\_wang@lch.com.tw

Website: www.lch.com.tw

Booth No.: D0501

### Horizontal Machining Center

The MH-500A small-middle size design is specifically for small-middle parts, suitable for machining hardware and automotive parts.

Automatic Pallet Change

With high speed pallet change and reduce non-cutting time of workpiece setup. The precision tapered orientation ensure the



stability of pallet change.

Feature:

1. The column is designed with a symmetrical double-wall structure, in order to prevent from temperature growth which would cause of generating the thermal deformation and affecting cutting accuracy.

2. Adopting the high-intensive base not only prevent the vibration but raise the cutting stability.

3. The spindle with short nose design to exhibit exceptional rigidity. The spindle head is designed by Finite Element Analysis to achieve an optimal structure with increased length of locking surface, making it easily for deep holes processing.

4. The magazine install in the above that has less interference region, and the short tool arm has rapid tool change rate.

5. The machine with compact construction, which has minimum using space that increase the square feet of factory.

#### MASTER Automatic Co., Ltd.

Tel: +886-4-2525-0480\*202

Fax: +886-4-2525-7747

E-mail: claire@macocnc.com

Website: www.macocnc.com

Booth No.: K0322

### WEI GUAN Cutting Tool

Right tool for right job.

1. Horizontally withdraw axis of the tool, tightening fixture allowing tool tightening, fixture to rotate both left and right at an angle of 45° for a total of five rotating.

2. Rapidly and efficiently in securing tool, tightening fixture system can effectively prevent the shank from falling when secured to the cutter horizontally.



#### WEI GUAN Cutting Tools Co., Ltd.

Tel: +886-4-2492-9135

Fax: +886-4-2492-9256

E-mail: info@wei-guan.com.tw

Website: www.wei-guan.com.tw

Booth No.: TWTC Hall 1/D0401

### Metal Slitting Lines TDS-700

TOA DR Enterprise Co., Ltd. was established in 1972. The company

specialises in the manufacturing of metal slitting machines and whole plant sales in Taiwan. It holds several product line patents and can customise lines for customers. With a strong team of designers (one third of the company's employees), TOA DR has facilitated several machine systems including a hydraulic slitting knife-locking system and friction recoil system. Its main aim is to increase processing efficiency as well as quality.



#### TOA DR Enterprise Co., Ltd.

Tel: +886-2-2995-7607

Fax: +886-2-2995-5048

E-mail: sales@slitterline.com

Website: www.slitterline.com

Booth No.: C0318

### SHUTER CNC Tool Storage Cart

Model: TW-CT4BHA

Functions:

SHUTER CNC Tool Storage Cart is a customisable premium unit ideal for those who need ultimate tool storage solutions in large or small workspaces. It is suitable for a wide range of CNC components and accessories. The cart can be fitted with can be fitted with a range of optional fixtures to increase storage, such as an international standard square peghole backboard, tool holder customisations, and SHUTER quick tip out and hanging bins.

Features:

1. Four CNC tool holder customisations are available, all designed to European standard specifications

2. The sides of the cart are fitted with international standard square-hole pegboards, ideal for holding a wide range of hand tools and accessories.

3. For ease of use, one side of the top storage console is designed to hold long, narrow tools that are currently in use, while the other is suitable for drivers, hexagonal wrenches, and more.

4. The base of the cart features a tall-sided tray suitable for safely holding larger objects.

#### Shuter Enterprise Co., Ltd.

Tel: +886-4-2335-8800

Fax: +886-4-2335-8577

E-mail: fa208@shuter.com.tw

Website: www.shuter.com.tw

Booth No.: B0312



### Indexable Center Drill 60°

1. Close to zero point eccentricity design, Precise center, Strong Centering point, Carbide insert, Special geometry will increase tool-life and efficiency and reduces set up time of putting new tool.

2. Close to zero point eccentricity, tolerance ±0.008mm, cutting edges will not break easily.

3. Zero point eccentricity design, precise center and very strong Centering point.

4. Special insert grade 350 will give longer tool-life and increase efficiency

5. Can do center hole.

#### YIH TROUN Enterprise Co., Ltd.

Tel: +886-2-8521-3035

Fax: +886-2-8522-3039

Email: a003@cut-tools.com.tw

Website: www.cut-tools.com.tw

Booth No.: A0424

### High Feed Milling Cutter Series (CXBN)

TDS-700

Introducing our first high feed milling cutter series (CXBN) with insert that combined provide more teeth per diameter for higher productivity. CXBN Series is suitable for high-velocity, high-speed cutter of steel materials, especially when performed on smaller machines equipped with high-speed and low torque spindles.

CXBN High feed inserts feature two cutting edges per side. The inserts



effectively machine materials such as mould Steel, Carbon Steel and Stainless Steel.

Designed with four cutting edges, the CXBN High Feed insert provides low cutting resistance for cost-effective and high-performance machining of common work piece materials when using cutter body diameters from 20mm to 63mm.

Features:

• Particularly suitable for high feed milling purpose.

• 4 Corner Inserts for cost effective and efficiency.

• Designed for low cutting force.

• Minimum diameter 16mm with 1mm of maximum D.O.C.

#### Winstar Cutting Technologies Corp

Tel: +886-6-3840-386

Fax: +886-6-3840-387

E-mail: sales@slitterline.com

Website: www.winstarcutting.com

Booth No.: B0828



**Centralized Lubrication System**



The company establishes to 1976, specialized manufacture research and development lubrication system and each related oil duct disposition.

This company grasps “Innovation, Stability” as a target. They not only provide the product service, (but also) includes each technological exchange in among with the user. to research and develop the humanized product item to meet the changes of the market.

**YUNG TIEN Lubrication Tech., Ltd.**

Tel: +886-4-2528-4429

Fax: +886-4-2524-2345

E-mail: [chiba.tw@gmail.com](mailto:chiba.tw@gmail.com)

Website: [www.chiba.com.tw](http://www.chiba.com.tw)

Booth No.: R0103

**Precision High Speed Expanded Metal Machine**

Model : XP-35-SF

This newly developed precision high speed machine continues JUNEN reputation for high efficiency and stability of productivity, in response to the needs of fine mesh in electric conduction industry. This allows production of thickness as small as 0.1mm, mesh size only 0.5 x 1.0mm under maximum speed of 1,800 s.p.m. The advantage of our customers is acquiring a high quality and productive machine that has been recognized by leading companies in the industry from Japan, USA, and Australia with reasonable price. The best part is that our customers benefit from continuous breakthrough in user experience and production know-how as we are also the user of JUNEN machine.

**JUN-EN Enterprise Corporation**

Tel: +886-7-3737-800

Fax: +886-7-3737-900

E-mail: [enping.yang@junen.com.tw](mailto:enping.yang@junen.com.tw)

Website: [www.junen.com.tw](http://www.junen.com.tw)

Booth No.: C0832



**CS-102 Pulsed Dust Collector**

CS-102 Pulsed Dust Collector (for Dry and Wet Applications)

1. The main body is made from stainless steel 304, featuring long durability and easy to clean.

2. Employ cyclonic centrifugal principle to suck powder or granule into bottom drum.

3. The blower is applied for sucking air only. The sucked dusts do not directly contact with motor for increased service life of motor.

4. Allows for 24 hours operation.

5. The filter-core allows for filter powder of up to 0.1µm(micron)

6. Various motor horsepower : specification to meet specific requiremen

7. The innovative dust collector Taiwan with automatically pulsated filter core features silent operation, without need to change filtering bag.

8. Explosion-proof dust collector. magnesium alloy, aluminum alloy, graphite fiber, chemical, food can be used.

**YU CHA Company**

Tel: +886-4-2515-6553

Fax: +886-4-2523-0799

E-mail: [yu.cha@msa.hinet.net](mailto:yu.cha@msa.hinet.net)

Booth No.: G0602





[www.posa-spindle.com](http://www.posa-spindle.com)



**Pioneer of Spindle Area**  
**26 Years Advancing Technology**  
**The best manufacturing option for Industry 4.0**





**It is measured by a dial gauge ≤ 0.002mm,**  
**Test bar 300mm ≤ 0.005mm**



 2019/3/4-9  
 27<sup>th</sup> Taipei Int'l Machine Tool Show  
**Booth No. Q0502**

**POSA MACHINERY CO., LTD.**  
**TEL: 886-4-2213-5988 Email: [posa.posa@msa.hinet.net](mailto:posa.posa@msa.hinet.net)**

 spindleposa





## Exhibit Highlights

### YSM CNC-39T Strip & Wire Forming Machine

YSM-CNC 39T is the advanced type, it is the three-axis servo forming machine. The thickness of strip is 0.8-3.0mm, and up to max width of strip is 60 mm; wire diameter is Ø1.5 – 6.5 mm. It can process even more clamp items and further. Due to its three-axis CNC structure, it is flexible to mold change. Engineer explained that, due to the CNC advancement, when the mold design is changed, the YSM CNC-39T can adopt to the change, without further trouble and keep up with the manufacture step. This type of CNC forming machine is good at keep production line agile.

**YIH SHEN Machinery Co., Ltd.**

Tel: +886-4-2337-5168

Fax: +886-4-2337-2962

E-mail: [info@ysm.com.tw](mailto:info@ysm.com.tw)

Website: [ysm.com.tw](http://ysm.com.tw)

**Booth No.: D0301**



### Suspended type / Portable Spot Welding Machine

Welding Process Industrial Co., Ltd. (WPI Taiwan) is a professional designer and manufacturer of Suspended type / Portable Spot Welding Machine. With 40 years' experience and constant innovation, self-



designed transformer and cylinder, WPI has successfully become the main developer and the local manufacturer of Suspended Type / Portable Spot Welding Gun.

**WELDING Process Industrial Co., Ltd.**

Tel: +886-4-2407-0658

Fax: +886-4-2407-0657

E-mail: [welding@ms14@hinet.net](mailto:welding@ms14@hinet.net)

Website: [www.wpitaiwan.com](http://www.wpitaiwan.com)

**Booth No.: C0936**

### WIFI Control

WIFI Monitoring - The built-in WIFI wireless module is optional and can be used in servo motors instantly uploaded to sever, providing remote monitoring to users for use under operating conditions.

The error can be eliminated using online customers, recorded and records can be traced back more customers to use. If there is any abnormal condition, systems can be improved or notify customers the relevant parts replacement service life early maturing.

App Modification at anytime-Online Monitoring-Customized mobile-apps can be 24 hours of Internet access to monitor and eliminate the use of remote client.

**MACRO MAKOTO Enterprise Co., Ltd.**

Tel: +886-2-2679-3289

Fax: +886-2-2269-1460

E-mail: [judy@homerunmotor.com](mailto:judy@homerunmotor.com)

**Booth No.: G0261**



### ARK Series Oil Mist Collector

The original cylindrical special filter design patent. The oil mist separation design meets the standards of the World Environmental Organization. The front filter cotton can be repeatedly used for cleaning. It has low failure rate and easy maintenance. It can absorb oil mist with PM2.5 up to 99%. After filtration and purification, it can be recycled and reused. The motor is designed and developed with large air volume, low noise and super power saving. High efficiency, small size, easy to install in tight spaces or machinery. Easy to install, it can be widely used in all workplaces that produce oil mist.

**Ming Guang Motor Co., Ltd.**

Tel: +886-4-2277-2025

Fax: +886-4-2277-1173

E-mail: [a23392028@gmail.com](mailto:a23392028@gmail.com)

**Booth No.: 0522**

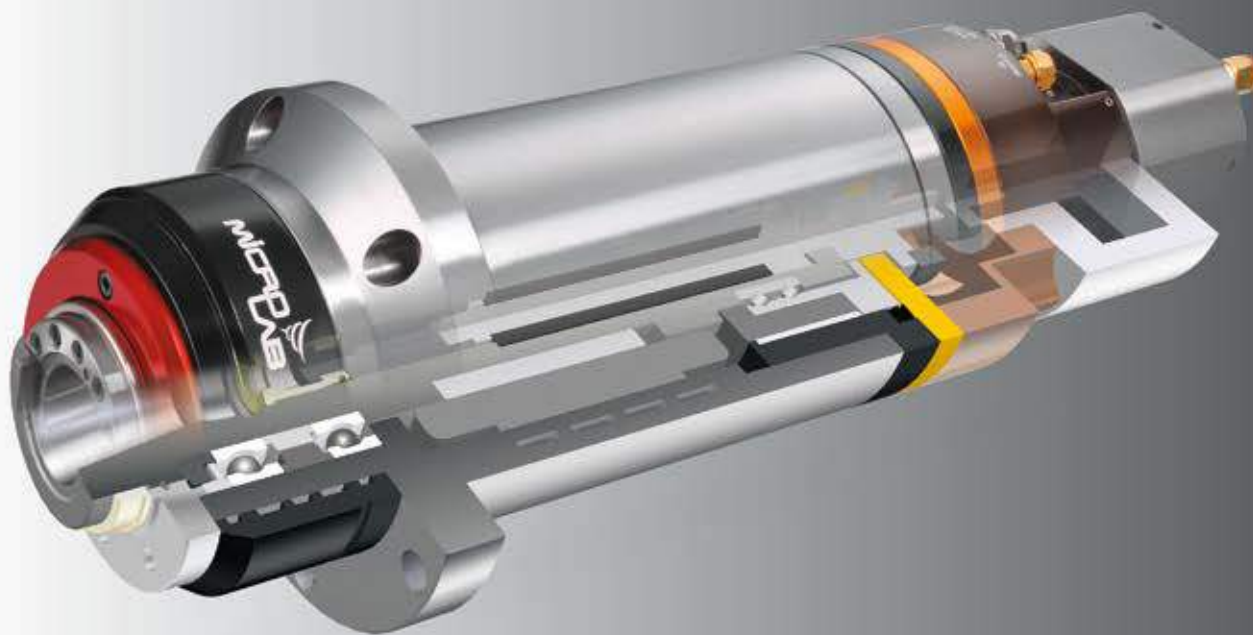

**Integration of High Performance Technology  
Perfect Process Control to  
Ensure Stable Quality**



**TIMTOS**  
第 27 屆台北國際工具機展  
The 27th Taipei Int'l Machine Tool Show

March 4-9, 2019  
TAIPEI NANGANG Exhibition Center, Hall 2  
**SITE: Q1212**

矩將科技有限公司 | MicroLab Precision Technology Co., Ltd |  
Tel: +886-4-22392345 / Fax: +886-4-22392357 / E-mail: [microlab@twspindle.com](mailto:microlab@twspindle.com)  
台中市40643北屯區松竹路一段530號  
<http://www.twspindle.com>



## Exhibit Highlights

### AEGIS Multi-tasking Turning Center

AEGIS slant bed CNC Lathe machines are high accuracy turning and milling complex CNC Lathe. The series of machines is equipped with a 12 positions live turret in combination with C-axis function, allowing turning, side and face milling, boring, drilling and tapping to be accomplished in one setup. Especially we provide C1 & C3 accuracy grade ball screw on X & Z axis to ensure the machine precision. Also, we install power enough motor on the spindle and servo axes.

**FIRST CHANT Enterprise Co., Ltd.**

Tel: +886-4-2559-0525

Fax: +886-4-2559-0387

E-mail: [catherine@first-chant.com](mailto:catherine@first-chant.com)

Booth No.: G0454



### Closed Bridge Type Engraving and Milling Machine-EM432

The Closed-Bridge type construction, combined with extra strong box type columns eliminate rigidity displacement while the spindle head is moving.



Our CNC engraving machines are suitable for machining of precision products, cooper electrodes, precision die moulds, bronzing moulds, plastic dripping moulds, hot cutting moulds, mould lettering and mini type injection moulds.

Especially for machining those products with requirements of high smooth finish, such as for optics equipment surface and electrical semiconductor, mobile phone, etc.

The machine is rather salable machine due to its high machining precision, low usage cost, high machining efficiency for high precision products, legerity structure,

convenient operation, good performance.

**HSIU FONG Machinery Co., Ltd.**

Tel: +886-4-2279-2121

Fax: +886-4-2270-9039

E-mail: [sales@surefirst.com.tw](mailto:sales@surefirst.com.tw)

Booth No.: G0226

### INTEGREX AG Series

Hybrid multi-tasking machines

- Produce gear without dedicated gear cutting machine

- Perform high accuracy gear cutting on the INTEGREX AG plus measurement and machining compensation

- Integrated processing ensures minimum production lead time for gear processing

**YAMAZAKI MAZAK Taiwan Corporation**

Tel: +886-4-2350-9811

Fax: +886-4-2350-9812

E-mail: [Weichiao\\_Liu@tw.mazak.com](mailto:Weichiao_Liu@tw.mazak.com)

Website: [www.mazak.com.tw](http://www.mazak.com.tw)

Booth No.: I0316



### VS Series Programmable Controller

VS series controller are designed for high-function and supplied all-inclusive control as well as application to enhance, Vigor product competition and achieve high reliable quantity with reasonable price.

VSM Motion Control type: For a variety of positioning control systems. Such as Labeling/Shrink Sleeve Machine, Dispenser, Film Laminating machine, Pipe Bending machine, Cutting machine, Bar feeder, etc., need to meet various Servo/Stepper motors to perform precise position control industry.

**VIGOR Electric Corp.**

Tel: +886-2-2620-4393

Fax: +886-2-2620-4976

E-mail: [angie@vigorplc.com.tw](mailto:angie@vigorplc.com.tw)

Booth No.: G0410

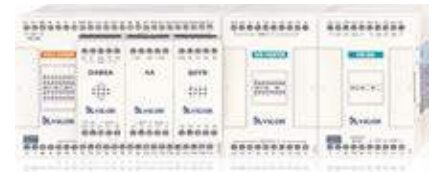

自1961年我們就在全球持續突破與創新，提供你全方位棒材加工

We deliver the innovation worldwide since 1961 in order to provide you the full range of bar-working



#### Elite ZERO/112 / 220

Ø 0.3 / Ø 0.8-12.7 / Ø 2-20  
1.8M/3.2M/3.7M



#### Steady 326

Ø 3-26  
3.2M



#### Boss 542 / 551

Ø 5-42 / Ø 5-51  
2.5M/3.2M/3.7M/4.4M



#### Master Series

Ø 8-80 / Ø 30-100  
2.1M/3.3M/3.8M/4.3M

中義科技機械(股)公司 GIULIANI IEMCA MACHINERY CO., LTD. Tel. 886-4-24066970

 **TIMTOS** Booth No. N0519  
Nangang Exhibition Hall 1  
We welcome your visit sincerely



# 70<sup>th</sup> ANNI WERSARY



**TIMTOS**  
27th Taipei Int'l Machine Tool Show

stand/

**10626**

**04 - 09, Mar. 2019**



“遠東機械集團—發得科技工業(股)”  
(Tel)+886 5 213 3166/(Fax)+886 5 220 5293  
62154嘉義縣民雄鄉福樂村中山路26號  
<http://www.FATEK.com.tw>





DEFINE FUTURE

品質成就信任，智能定義未來



製造智慧科技·彈指之間  
遠東E智慧服務系統

**FEMTEC** 遠東機械集團  
**GROUP**



## Go Taipei Things to Do in Taipei

### Browse Books at Humanities & Culture Bookstores

Bookstores enrich the beauty of a city. Taipei has 24-hour bookstores that serve as quiet corners where night owls can read. The independent, second-hand, and antique bookstores of the NTU/Gongguan Commercial area are evidence of the cultural literacy of Taipei's citizens. Zhongshan Underground Book Street, the longest book street in Taiwan, transcending culture and generation, is packed with thousands of books and also has a music and movie section. The small stores selling coffee and adzuki bean cake etc. along the street add to the reading pleasure.



### Enjoy Coffee in a Distinctive Café



Visiting its cafés is one of the best ways to get to know Taipei. Many old houses in Dadaocheng have been renovated and now the tempting aroma of fine coffee wafts out from within. Characterful cafés with fine coffee can be found on Section 2 of Zhongshan North Road, Chifeng Street, Yongkang Street, Qingtian Street, and Fujin Street etc. Taipei's coffee culture has many charming faces. If you want to enjoy coffee culture from overseas and appreciate distinctive design, there are cafés that exude exotic charm. You can also visit cafés that have a compound operating model, offering a family space, reading corner or creative design base, adding an extra dimension to the coffee-drinking experience.

### Visit a Riverside Park and Go on a River Cruise



The Tamsui and Keelung rivers gently embrace this city. The people's lives are closely connected to the riverside parks, which are popular spots for early-morning runs, nighttime cycling, and other leisure activities. They are also venues for a variety of activities in the summer, attracting families and groups of friends to listen to concerts or play by the water to cool down. Boat trips on the Tamsui River can be taken from Dadaocheng Wharf, the "blue highway" offering different views of the city and riverbank scenery.

### View the Natural Scenery

As Taipei is surrounded by mountains and has a highly-developed transport system, it is fairly easy to get from the bustling city center to the mountains. Yangmingshan National Park is well-worth visiting to get close to nature and can be reached with a short bus journey from Shilin. Located not far from Xinyi shopping area, the Four Beasts Mountain trails are suited to hiking and are a great place to enjoy views of the New Year fireworks show and look out over the city. In Neihu District, Dahu Park, Baishi Lake Bridge, and Dagou Riverside Park are like city oases, offering relaxation for mind and body.



### EasyCard、iPASS

EasyCard and iPASS can be purchased at MRT station service desks and convenience stores. Once the card is charged, it can be used immediately. The cards can be used to pay transport fares and can also be used as an e-wallet for small purchases at convenience stores and other designated shops, and pay for YouBike rental fee.



### Taipei Fun Pass

There are three types of Taipei Fun Pass cards to choose from: "Unlimited Card" (tickets to 12 tourist spots + unlimited use of public transportation), "Transportation Card" (unlimited use of public transportation), and "Classic Card" (National Palace Museum and Taipei 101 Observatory tickets + stored-value EasyCard function). Within the cards' period of validity, tourists can travel in Taipei City, New Taipei City, and Keelung City more conveniently, and can purchase other travel products through the Taipei Fun Pass App or the official website.

Website



App



Text Source: Department of Information and Tourism, Taipei City Government



# 經典的工藝 · 精銳的演出

# CHENG CHANG MACHINERY

| HIGH PRECISION | LOW INERTIA | HIGH RESPONSIVITY |



**2019**  
Mar. 4-9  
27<sup>th</sup> Taipei Int'l Machine Tool Show  
南港二館一樓 P1028



---

#### SVM系列 (IP54)感應伺服器馬達

Compact Asynchronous motors Quick positioning. High torque moment.

**產品特性** 定位快速、精準、瞬間扭力大、低慣量設計、反應靈敏，高精度製程設計、符合您精密機械的需求。

**應用** 工具機主軸、印刷機械、塑膠射出成形機、分條/複捲機械、包裝機械、紡織機械、一般產業機械。



#### DD馬達 第四、五軸機構 · 內藏式主軸定轉子

Rotor&Stator(ER16,ER20,ISO250,BT30,BT40,P.C.B...等) / (100NT-M,200NT-M...等)

**產品特性** 定轉子特性媲美進口產品，規格參數齊全，適合各廠牌驅動器，控制器、規格產品齊全，亦可訂製。

**應用** 內藏式主軸、DD馬達。



---



#### SVMA系列 (IP23)感應伺服器馬達

(IP23)Compact Asynchronous motors Quick positioning. High torque moment.Efficient cooling

**產品特性** 定位快速、精準、瞬間扭力大、低慣量設計、反應靈敏，高效率冷卻設計，抗干擾線圈，高精度製程設計、符合您精密機械的需求。

**應用** 工具機主軸、印刷機械、塑膠射出成形機、壓鑄機、分條/複捲機械、包裝機械、紡織機械、沖床(延伸膜)、一般產業機械。

#### LINEAR MOTOR 線性馬達

The ironcore design for the higher efficiency of linear motor, and the higher speed and positioning accuracy than ball screw.

**產品特性** 有鐵心設計提高線性馬達效率。高效率的冷卻系統及較高的佔槽率大大提高線性馬達的功率體積比。

**應用** P,C,B鑽孔機、工具機、產業機械。



---

#### SPMA系列 同步伺服器馬達

Compact Synchronous motors Good speed control & torque control.

**產品特性** 高精度、低慣量設計、反應靈敏，速度控制、位置控制、轉矩控制、特性優越符合您精密機械的需求。

**應用** 工具機主軸、印刷機械、塑膠射出成形機、分條/複捲機械、包裝機械、紡織機械、一般產業機械。



#### DDM系列 直驅伺服器馬達

Suits injection molders, die-casting machines, machine tools, escalators, elevators, printers and industrial machines that require low speed, high-torque drive.

**產品特性** 取代減速機構，節約設備成本，噪音低、效率高、低速高扭力，提高控制精度，提升產品品質。

**應用** 注塑機攪料、壓鑄機、工具機、電梯扶梯、印刷機械、一般產業機械、低速高扭力的應用。



**晟昌機電股份有限公司** CHENG CHANG MACHINE ELECTRONIC CORP.

43641 台灣台中市清水區和陸路一段1005巷89號 | TEL : 886-4-26202888 | FAX : 886-4-26202777  
No.89, Ln. 1005, Sec. 1, Hemu Rd., Qingshui Dist., Taichung City 43641, Taiwan (R.O.C.)

**廈門晟勝數控設備有限公司** XIAMEN CHENGSHENG NC EQUIPMENT CO., LTD.

廈門同安區金富路100號B棟3樓東側郵編361100 | TEL : 86-592-7191900 | FAX : 86-592-7191961  
No.100, B Building 3rd Floor East Side, Jin-Fu Road, Tong-An District, Xiamen City, 361100



Sol.power@solpower.com.tw  
Sol.power@msa.hinet.net





參觀總人數: 12,757  
 國外: 4,127 國內: 8,630

Scan QR-Code and View more on APP and Wechat



TIMTOS APP



Wechat

# 彰顯智慧創新

## 第14屆工具機研究發展創新產品競賽頒獎盛典



3月5日晚，激動人心的「工具機研究發展創新產品競賽」評選結果揭曉，TIMTOS 2019歡迎酒會也同期舉行。

此次，共有40家廠商的43件作品參加競賽，廠商家數與件數及研發水準較上屆更多、競爭更激烈，研發水準更高、作品更細膩。今年新增加由所有參賽工具機類及零組件類，得綜合評選出智慧工具機或零組件特別獎1名與佳作獎3名，以表揚本屆智慧工具機或零組件研究發展的創新成果。

在智慧功能方面，工具機及關鍵零組件的智慧功能及感測器的應用有較大進步，且智慧型製造單元系統亦有進一步改善，達國際水準。而部份廠商也自製感測器應用於工具機及關鍵零組件上，愈來愈多業者也應用虛擬實境(VR)和擴增實境(AR)於工具機的操作介面、保養維修及市場推廣上。

## 2019年第14屆工具機「研究發展創新產品」競賽活動得獎廠商名單

參項CNC工具機類另綜合評選出特優獎		
獎別	公司名稱	作品名稱
特優獎	慶鴻機電工業股份有限公司	HD886L-高速銑削放電複合機
綜合加工機類		
獎別	公司名稱	作品名稱
優等獎	永進機械工業股份有限公司	NFX800B-MPS多軸化智慧彈性製造單元
佳作獎	凱柏精密機械股份有限公司	NV-1280立式加工機
佳作獎	百德機械股份有限公司	UX500P APC五軸加工中心機
佳作獎	新穎機械工業股份有限公司	CNC龍門五軸加工中心機(重切削型)-S5A-4732HH
CNC 車床類		
獎別	公司名稱	作品名稱
優等獎	程泰機械股份有限公司	GTW-1500 上刀塔下櫥式多軸車削中心
佳作獎	永詮機器工業股份有限公司	智慧重型多軸複合切削機,LLS-M
佳作獎	凱柏精密機械股份有限公司	CNC車銑複合機NT-208 SY
其他數控工具機類		
獎別	公司名稱	作品名稱
優等獎	慶鴻機電工業股份有限公司	RV853L智能化線性馬達驅動線切割機
佳作獎	徠通科技股份有限公司	AP+6040A+線切割放電加工機
佳作獎	鼎維工業股份有限公司	TP-4四軸CNC外圓磨床
佳作獎	精呈科技股份有限公司	NP500L 智慧化高精度線馬線切割加工機
數值控制工具機關鍵零組件類		
獎別	公司名稱	作品名稱
優等獎	上銀科技股份有限公司	冷卻式C3滾珠螺桿, R40-16K3-FDCC3
佳作獎	新代科技股份有限公司	基於Ethernet-based的開放式控制器-新代控制器220MA
佳作獎	大銀微系統股份有限公司	絕對式解角器直驅馬達系統TMY65D
佳作獎	哈伯精密股份有限公司	HIG 系列之DC變頻冷卻機HBO-N750PTSA8
所有參賽工具機類及零組件類，得綜合評選出智慧工具機或零組件特別獎		
獎別	公司名稱	作品名稱
特別獎	永進機械工業股份有限公司	NFX800B-MPS多軸化智慧彈性製造單元
佳作獎	慶鴻機電工業股份有限公司	RV853L智能化線性馬達驅動線切割機
佳作獎	新代科技股份有限公司	基於Ethernet-based的開放式控制器-新代控制器220MA
佳作獎	協易機械工業股份有限公司	智能製造管理系統



## TAMI與PENFEIA簽定協議 創造臺馬合作商機



臺灣機械工業同業公會 (TAMI) 與馬來西亞檳城機器廠商會 (PENFEIA) 於5日下午在臺北南港展覽館1館4樓貴賓室，舉行簽定合作協議 (MoU)，期望未來雙方將創造更多的商機與合作交流的機會。

臺灣機械公會秘書長王正青、馬來西亞檳城機器廠商會會長鄭美昌分別代表雙方簽訂合作協議，並由機械公會工具機委員會會長陳燦輝、檳城州立法會議議長拿督劉子健見證。

王正青秘書長在會中表示，臺灣的產業鏈非常完整，除工具機的廠商外，還有配套的零組件廠商，比起日

本、歐洲、海外廠商可以在臺灣找到產品品質及價格更有優勢的產品，把市場行銷到東南亞。

檳城機器廠商會會長鄭美昌表示，檳城自1970年代以來，號稱是東方矽谷，有300多家廠商在此建立基地，重點項目有半導體、電子電機、及當地產業，而自動化產業及電子電機都是成長快速的產業。

鄭美昌指出，很多臺灣的廠商已經達到工業4.0標準，希望可以向臺灣機械公會學習。期許未來可以簽定雙邊貿易協定，創造更多合作與交流機會。

## 工業4.0智慧製造無人化 模具製程30天縮到7天

工業4.0的發展，在臺灣工具機產業目前已經越趨成熟，有多家廠商陸續推出完整的系統化產品，可以從設計圖丟進去，就做到少人化或無人化，系統機器會自動處理整個製造過程。今天在TIMTOS台北國際工具機展的「工業4.0智慧製造研討會」上，兩家臺灣廠商合作推出完整的線切割機智慧化系統，可以把模具的整個製程，從過去需要一個月的時間，大幅縮短到只要七天。

業者指出，他們這套線切割機智能生產單元，設計圖進入系統以後就不再需要人力操作，系統會根據設計

圖自動分類各部件分別安排製程。透過機械手臂，這套機器可以自動把物料從料倉拉出來，再用量測系統輔助定位，即可把物料放進線割機，完全免去人力安裝校正。

而線割機最強的功能，就是它的自動取廢料系統，它可以把線割加工完的廢料都自動移除，不再需要人工處理。

而且這套系統可以做到真正的工業4.0，因為它不只可以智慧化處理既訂排程，還可以接急單，系統會視各部機器的工作情況，很有智慧的插單排程生產。



## 承襲精準的傳統 追求精度 力求卓越

憑藉著海德漢在量測領域超過百年來的專注、不斷的創新與研發，我們將能滿足您對高精度工具機的需求。海德漢將是您不二首選的最佳夥伴。

HEIDENHAIN

TIMTOS

歡迎蒞臨 TIMTOS 2019  
南港二館 Q0124  
2019年3月4~9日



想了解更多量測方案，請掃描QR Code

海德漢股份有限公司 40768 台中市工業區33路29號 電話：(04)2358-8977 <http://www.heidenhain.tw>

角度編碼器 + 光學尺 + 輪廓控制器 + 位置顯示器 + 長度規 + 旋轉編碼器



## 連接未來，TIMTOS 2019高峰論壇隆重登場

作為TIMTOS 2019的重頭戲之一，為期兩天的TIMTOS 高峰論壇於3月5日在臺北國際會議中心如期舉辦。中華民國對外貿易發展協會林芳苗副秘書長、臺灣機械工業同業公會柯拔希理事長分別進行了開幕致詞。

此次論壇以“Connecting to the Future”（連接未來）為主題，聚焦於智慧製造領域的熱門議題，共包含智慧聯網、積層製造、航太智慧製造、汽車製造業變革四大主題。為了給現場聽眾更好的參會體驗，第一天的論壇主要集中在智慧聯網和積層製造兩大方面。

在上午場的智慧聯網主題篇，來自SAP的全球解決方案經理Bernhard Meyer、ITTS東捷資訊服務副總經理劉新正、虎尾科技大學覺文郁校長、美國辛辛那提大學李傑教授分別從實際應用案例、技術研究、產學研合作的角度，針對目前廣大企業在推展生產智慧化的過程中會遇到的一些重點和難題進行了講解和剖析。譬如：工業4.0、智慧製造如何更好地服務現有的製造工藝，如何優化各種資料資源的整合，合理利用物聯網、大數據、人工智慧、VR虛擬實境等技術開拓新的商業模式、提升企業的獲利能力等



等。而在臺灣機械工業同業公會莊國欽榮譽理事長主持的“未來製造工作型態”的主題對談環節，不少觀眾更是踴躍向各位主講人提問，顯示了對智慧製造的強烈興趣。

下午場的積層製造主題篇，則著重於分享目前各種前沿的3D列印技術和實際應用案例。來自DMG MORI的營運長Neun Harald、Optomec亞太區總監Pascal Pierra、馬路科技大中華區銷售經理楊奇杰，分別帶來《未來製造業的高端加工技術解決方案》、《金屬增材製造的變革：提升工具機的整體結構》、《增材製造實現快速生產》等演講。幾位主講人都肯定了3D列印在零組件修復方面的巨大應用前景和價值。在最後的主題對談環節，來自數位時代的路怡珍主播也引導幾位主講人和觀眾進行了熱烈的互動，更是對如何降低3D列印的製造成本、如何更好地對3D列印技術的使用進行監管，諸如是否會存在消費者會利用3D列印技術列印槍支等危險物品類似的經濟社會問題進行了深入探討。■



### 超強動力 來自完美結構

GT新虎將 專業三軸·五軸高速機



**GT-1612V**  
門型高速加工中心機  
High Speed Double Column Machining Center



**GT-SP45 Linear**  
門型超精密線馬型加工中心機  
Ultra High Precision Double Column Machining Center with Linear Motor Drive



**GT-ML800**  
五軸銑車複合機  
5 axis Mill-Turn Machining Center



**GT-H2517F**  
天車式五軸高速加工中心機  
Gantry type 5 axis High Speed Machining Center

歡迎蒞臨  
台北國際工具機展  
**TIMTOS** 2019/3/4-9  
Taipei Int'l Machine Tool Show  
南港一館 J0410

**新虎將機械工業股份有限公司**  
GENTIGER MACHINERY INDUSTRIAL CO., LTD.  
www.gentiger.com.tw E-mail: GT@gentiger.com.tw  
Tel: +886-4-2683 6919 Fax: +886-4-2683 9900

**精密銑床、  
CNC 高速機領導品牌**



「2019年台北國際工具機展」研討會/活動日程表

日期	時間	活動內容 / 講題	主 / 協辦單位	地點	備註	
3月4日 (星期一)	10:30	開幕典禮	外貿協會·機械公會	南港展覽館 2 館 4 樓門廳	憑邀請函入場 簡韻茗小姐 +886-2-27255200#2867	
	8:00-17:00	Bfuture 全球新品發布會	慶鴻機電工業股份有限公司	南港展覽館 1 館 402c 會議室	林盈函小姐 +886-4-23509188#527	
	8:00-17:00	發格控制器及光學尺產品介紹	發格自動化股份有限公司	南港展覽館 2 館 602 會議室	溫恕民先生 +886-4-23851558	
	13:30-16:30	2019 台北國際工具機展採購洽談會	外貿協會	南港展覽館 1 館 504 會議室	柯采慧小姐 +886-2-27255200#1573	
	14:00-15:00	2019 台北國際工具機展記者會	外貿協會·機械公會	南港展覽館 1 館 403 會議室	侯馨青小姐 +886-2-23494677	
	16:00-17:30	馬來西亞機械市場說明會暨 TAITRA 及 PENFEIA 合作備忘錄簽約典禮	外貿協會	南港展覽館 1 館 404 會議室	陳冠儒小姐 +886-2-27255200#2693	
3月5日 (星期二)	8:00-17:00	Bfuture 全球新品發布會	慶鴻機電工業股份有限公司	南港展覽館 1 館 402c 會議室	林盈函小姐 +886-4-23509188#527	
	8:00-17:00	發格控制器及光學尺產品介紹	發格自動化股份有限公司	南港展覽館 2 館 602 會議室	溫恕民先生 +886-4-23851558	
	8:30-12:00	工具機關鍵模組暨智慧製造應用技術發表	工研院智慧機械科技中心	南港展覽館 1 館 505a 會議室	張惠怡小姐 +886-49-2345309	
	9:00-12:00	台日機械企業經貿交流會	機械公會	南港展覽館 1 館 504bc 會議室	王篠傑先生 +886-2-23494668	
	9:00-16:00	TIMTOS 2019 高峰論壇	經濟部國際貿易局	台北國際會議中心 101 會議室	高麗茹小姐 +886-2-27255200#2679	
	16:00-17:00	德國工藝 享譽國際 - 德國工具機產業發展新趨勢	外貿協會德經處	台北國際會議中心 101 會議室	鄭芳姿小姐 +886-2-7735-7524	
	10:00-12:00	《工具機組裝新利器 -Renishaw 全新 XK10 校準雷射系統》新品發表會	雷尼紹股份有限公司	南港展覽館 1 館 402a 會議室	莊詠偉先生 +886-4-24603799	
	10:30-12:00	TNC 640 高效率五軸輪廓控制器 - 高可靠度創新加工技術的優勢	海德漢股份有限公司	南港展覽館 1 館 403 會議室	蔡語耕小姐 +886-4-2358-8977 #1035	
	13:00-15:00	NIDEC-Commander C 產品發表會	睿欣實業股份有限公司	世貿一館 第 4 會議室	陳曦小姐 +886-4-22606502	
	13:00-15:00	工業 4.0 智慧製造研討會 / 模具智能化生產單元	徠通科技股份有限公司	南港展覽館 1 館 402ab 會議室	張詠晴小姐 +886-4-23599688#226	
	15:30-18:00	徠通科技全球代理商會議	徠通科技股份有限公司	南港展覽館 1 館 402ab 會議室	張詠晴小姐 +886-4-23599688#226	
	14:00-15:00	2020 年日本國際工具機展覽會 JIMTOF 記者會	日本工作機械工業會	南港展覽館 1 館 404 會議室	+81-3-34343961	
	14:30-16:30	智慧製造聯網數據增值產業聯盟會員大會	財團法人工業技術研究院 ITRI	南港展覽館 1 館 504a 會議室	陳玉雲小姐 +886-3-5916720	
	15:00-16:00	臺灣機械工業同業公會與馬來西亞檳城機器廠商會簽訂合作協議	機械公會	南港展覽館 1 館 4 樓貴賓簡報室	林子鈞先生 +886-2-23494694	
	15:00-17:30	台灣麗馳全球代理商大會暨新產品發表會	台灣麗馳科技股份有限公司	南港展覽館 1 館 401 會議室	莫金燕小姐 +886-4-26815711#246	
	18:30	2019 年台北國際工具機展歡迎酒會暨工具機研究發展創新產品競賽頒獎典禮	工具機發展基金會·外貿協會·機械公會	南港展覽館 1 館 3 樓燴館宴會廳	蔡宜真小姐 +886-2-23110358	
	3月6日 (星期三)	8:00-17:00	Bfuture 全球新品發布會	慶鴻機電工業股份有限公司	南港展覽館 1 館 402c 會議室	林盈函小姐 +886-4-23509188#527
		8:00-17:00	「2019 年台北國際工具機展」高中職、大專、大學、研究所導覽活動	機械公會	南港展覽館 1 館 500 會議室	黃雅華小姐 +886-2-23494672
8:00-17:00		發格控制器及光學尺產品介紹	發格自動化股份有限公司	南港展覽館 2 館 602 會議室	溫恕民先生 +886-4-23851558	
9:00-16:00		TIMTOS 2019 高峰論壇	經濟部國際貿易局	台北國際會議中心 101 會議室	高麗茹小姐 +886-2-27255200#2679	
16:00-17:00		德國工藝 享譽國際 - 德國工具機產業發展新趨勢	外貿協會德經處	台北國際會議中心 101 會議室	鄭芳姿小姐 +886-2-7735-7524	
8:00-17:00		工業 4.0 與智慧機械技術應用趨勢研討會	台灣易格斯有限公司 遠播資訊股份有限公司	南港展覽館 1 館 505 會議室	孫桂芬小姐 +886-2-25855526#225	
9:00-11:00		永進機械代理商會議	永進機械工業股份有限公司	南港展覽館 1 館 401 會議室	陳家欣小姐 +886-4-25623211#1812	
10:30-12:00		選擇美國投資研討會 - 錢進美國教戰守則	美國在台協會商務組 臺灣機械工業同業公會	南港展覽館 1 館 501 會議室	+886-2-27201550#334	
13:00-17:00		新產品說明會	喬崑進科技股份有限公司	南港展覽館 1 館 502 會議室	黃悖密小姐 +886-4-22712000#231	
13:00-17:00		程泰集團年度產品發表會	程泰集團	南港展覽館 1 館 504a 會議室	江苡璉小姐 +886-4-24629698#62107	
13:30-16:30		礦物複合材料 (人造花崗石) 在機械領域的應用	山東納諾新材料科技有限公司	南港展覽館 1 館 404 會議室	崔美麗小姐 +86-531-88917773	
13:30-17:00		中國砂輪新產品發表會	中國砂輪企業股份有限公司	世貿一館 第 2 會議室	王文仁先生 +886-2-26791931#3309	
8:00-17:00		直得科技新品說明會	直得科技股份有限公司	南港展覽館 1 館 3 樓福軒	李家慶先生 +886-6-5055858#162	
8:00-17:00		Bfuture 全球新品發布會	慶鴻機電工業股份有限公司	南港展覽館 1 館 402c 會議室	林盈函小姐 +886-4-23509188#527	
8:00-17:00		「2019 年台北國際工具機展」高中職、大專、大學、研究所導覽活動	機械公會	南港展覽館 1 館 500 會議室	黃雅華小姐 +886-2-23494672	
8:00-17:00		發格控制器及光學尺產品介紹	發格自動化股份有限公司	南港展覽館 2 館 602 會議室	溫恕民先生 +886-4-23851558	
13:30-17:00		2019 台北國際工具機展 GLORIA 智慧製造創新應用論壇	科技部·外貿協會·機械公會	南港展覽館 1 館 402ab 會議室	郭瑀璇小姐 886-2-25774249#827	
14:00-16:00		液壓系統節能技術與切削冷卻液之過濾處理	台灣賀德克技術有限公司 得霖企業有限公司	南港展覽館 1 館 502 會議室	楊雅淑小姐 +886-4-22602278	
14:00-16:00	研磨加工品質、效率的確保與提升	忠達貿易有限公司	南港展覽館 1 館 505b 會議室	張怡婷小姐 +886-2-29115226#607		
3月7日 (星期四)	8:00-17:00	直得科技新品說明會	直得科技股份有限公司	南港展覽館 1 館 3 樓福軒	李家慶先生 +886-6-5055858#162	
	8:00-17:00	Bfuture 全球新品發布會	慶鴻機電工業股份有限公司	南港展覽館 1 館 402c 會議室	林盈函小姐 +886-4-23509188#527	
	8:00-17:00	「2019 年台北國際工具機展」高中職、大專、大學、研究所導覽活動	機械公會	南港展覽館 1 館 500 會議室	黃雅華小姐 +886-2-23494672	
	8:00-17:00	發格控制器及光學尺產品介紹	發格自動化股份有限公司	南港展覽館 2 館 602 會議室	溫恕民先生 +886-4-23851558	
	13:30-17:00	2019 台北國際工具機展 GLORIA 智慧製造創新應用論壇	科技部·外貿協會·機械公會	南港展覽館 1 館 402ab 會議室	郭瑀璇小姐 +886-2-25774249#827	
	14:00-16:00	液壓系統節能技術與切削冷卻液之過濾處理	台灣賀德克技術有限公司 得霖企業有限公司	南港展覽館 1 館 502 會議室	楊雅淑小姐 886-4-22602278	
	14:00-16:00	研磨加工品質、效率的確保與提升	忠達貿易有限公司	南港展覽館 1 館 505b 會議室	張怡婷小姐 +886-2-29115226#607	
3月8日 (星期五)	8:00-17:00	直得科技新品說明會	直得科技股份有限公司	南港展覽館 1 館 3 樓福軒	李家慶先生 +886-6-5055858#162	
	8:00-17:00	Bfuture 全球新品發布會	慶鴻機電工業股份有限公司	南港展覽館 1 館 402c 會議室	林盈函小姐 +886-4-23509188#527	
	8:00-17:00	「2019 年台北國際工具機展」高中職、大專、大學、研究所導覽活動	機械公會	南港展覽館 1 館 500 會議室	黃雅華小姐 +886-2-23494672	
	8:00-17:00	發格控制器及光學尺產品介紹	發格自動化股份有限公司	南港展覽館 2 館 602 會議室	溫恕民先生 +886-4-23851558	
	9:30-18:00	智慧製造論壇	流線傳媒股份有限公司 外貿協會	世貿一館 第 4、5 會議室	林淑靜小姐 +886-2-87715865#180	
	9:30-14:00	迪普馬移動解決方案產品培訓研討會	迪普馬移動解決方案集團公司 羅昇企業股份有限公司	南港展覽館 1 館 502 會議室	吳容睿小姐 +886-2-29958400#1232	
	10:00-17:00	中興大學與精密機械研究發展中心 智慧機械產學論壇技術成果發表會	國立中興大學 & 財團法人精密機械研究發展中心	南港展覽館 1 館 403 會議室	葉湘琳小姐 +886-4-22858139	
	13:00-16:00	活用 3D 列印與 3D 量測科技，邁入 3D 智能檢測時代	馬路科技顧問股份有限公司	南港展覽館 1 館 404 會議室	林雨潔小姐 +886-2-2999-6788#284	
3月9日 (星期五)	8:00-17:00	「2019 年台北國際工具機展」高中職、大專、大學、研究所導覽活動	機械公會	南港展覽館 1 館 500 會議室	黃雅華小姐 +886-2-23494672	
	8:00-17:00	發格控制器及光學尺產品介紹	發格自動化股份有限公司	南港展覽館 2 館 602 會議室	溫恕民先生 +886-4-23851558	

如有修正，以現場實際狀況為準，不另通知。





他對臺灣工具機的品質優良印象最深刻，第一天就下單買了兩台立式加工中心機(VMC)。包第認為，臺灣的工具機有很多很好的科技，尤其這次TIMTOS展出許多完整的系統，他非常有興趣。對於展場的佈置安排，他覺得可以用「無懈可擊」來形容，他覺得展場無論什麼都安排得很好、很有秩序。

**卡勒·包第**  
埃及  
General Manager



Kathryn已經是第四次參觀TIMTOS了，她說很高興看到臺灣有如此多擁有抱負的製造業人才，他們有志通過技術來推動產業變革。在數位轉型和智慧製造趨勢的引領下，臺灣的業者是真正的技術創新驅動者。

**Kathryn Gerardo-Elagio**  
國際金屬加工商情 - 亞洲版  
菲律賓



作為TIMTOS官方每日快訊出版人，施建兵先生深切感受到了展覽主辦方的合作同事敬業、認真與細緻的工作風格。施先生認為，這是本屆TIMTOS展覽獲得其歷史上前所未有成功的眾多原因之一。在展覽上，他處處感受到了專業性，從展館接駁車、到媒體中心、甚至到廁所！

**施建兵**  
榮格工業傳媒  
中國大陸



他是第一次到臺灣，也是第一次看TIMTOS，埃希迪對於臺灣和展場所有的事情都感覺非常興奮，也非常滿意。他說，他在新加坡的展覽上只看到少許臺灣的工具機，這次在TIMTOS一次可以看到這麼多新機器，就很想一口氣看個夠。可是由於有四個展場七千個攤位，他怕自己來不及看完所有展出的產品。

**阿麥德·埃希迪**  
新加坡  
Eastern Trade Media Pte. Ltd.



她覺得展覽辦得很棒，主辦單位很用心，規格很高。第一，有很多漂亮的花，讓人心情愉悅；第二，展館設計別具匠心，很好找到攤位，尤其南港展覽2館多層展示很為參觀者著想；第三，廠商也很用心展出很先進產品，儘管有些臺灣企業相對歷史不是太長，但做出的成績還是十分令人矚目的！

**曹勝玉**  
北京金屬加工雜誌社  
編輯



從俄羅斯來看2019台北國際工具機展的伊麗莎薇塔說，她今年看到臺灣有一家廠商推出的CNC工具機，是她在其他國家從來沒有看到過的，包括日本的發那科、德國西門子，或德國海登海姆(Heidenheimer)的工具機展上，從來沒看過。她要報導這個消息，預計會刊登在五月號的Russian Industrial Regions雜誌上。

**伊麗莎薇塔·沃契柯夫絲卡雅**  
俄羅斯  
編輯

## 台灣精品太空梭正式於南港啟航 邀您體驗科技迷航

**位**於台北南港展覽館1館3樓的台灣精品館，以全新的太空梭場景登場，展出台灣精品最新得獎產品，帶領大家航向科技宇宙，認識台灣的驕傲！

主辦單位外貿協會表示，去年遷館至台北南港展覽館1館的台灣精品館歷時一個月的改裝及更換產品，裝潢全面翻新，搭配行星與太空場景，情境式展出得獎產品，包括指揮中控台、醫療實驗室等，讓每一位踏上太空梭的民眾在太空氣氛的視覺饗宴中欣賞各種類產品。此外，館內提供時下最夯的虛擬實境(VR)，來館的民眾可以身歷其境地體驗臺灣在VR上的成就。由台灣精品領航，一同朝更浩瀚的科技宇宙前進。

台灣精品太空梭展示榮獲第27屆台灣精品獎的40家品牌58件得獎產

品，產業涵蓋資通訊、運動休閒、生技醫療、智慧生活以及環保機能。台灣精品館像是美術館和博物館的綜合體，館內產品結合設計與創新，滿足參觀者對科技智慧的期待，館內有能偵測人臉辨識年齡，在冰箱上顯示數位廣告推薦飲品的無人商店智慧行銷顯示冰箱，也有可以無負擔的改變飲品質地，讓烈酒變得更甘韻、咖啡變得更順滑，甚至平淡的水都能嚐起來不一樣的驚奇瓶。喜歡運動休閒的朋友，踏入館內，不但能近距離欣賞兼具美型及性能的嘉鴻豪華遊艇模型，一窺海上移動豪宅樣貌，也能欣賞雷虎科技專為水下拍攝及探勘設計的無人潛艇。此外，也有專為電競玩家設置的專區，包括華碩ROG系列的電競

筆電及手機，宏碁Predator Galea電競耳機以及微星的輕薄電競筆電都能在館內體驗。

歡迎大家登上台灣精品太空梭，在星際間找到屬於自己最愛的台灣精品。台灣精品館每日皆有導覽員解說

及示範操作各項產品，平日開放民眾免費入館體驗(上午10時至晚上6時)，周末及假日則配合台北南港展覽館1館展覽檔期開館，一趟漫遊台灣科技宇宙星雲的旅程，一定能讓每位登上太空梭的旅客收穫滿滿。■





# 2019 年台北國際工具機展 高峰論壇

時間：2019年3月5日(二) 09:00-17:00  
地點：臺北國際會議中心101會議室 (臺北市信義區信義路五段1號)

時間：2019年3月6日(三) 09:00-17:00  
地點：臺北國際會議中心101會議室(臺北市信義區信義路五段1號)

主題一：智慧聯網	
時間	議程/講師
09:00-09:20	來賓報到
09:20-09:30	開場致詞 林芳苗 / 中華民國對外貿易發展協會副秘書長 柯拔希 / 臺灣機械工業同業公會理事長
09:30-10:10	【主題演講】How SAP helps Customers to Create Value with Industry 4.0 and Internet of Things in Discrete Industries Bernhard Meyer / SAP Global Solution Manager, Industry Business Unit, Industrial Machinery & Components (IM&C)
10:10-10:50	【主題演講】智能IoT智能機器管理平台 劉新正 / ITTS東捷資訊服務副總經理
10:50-11:30	【主題演講】從產學實踐台灣工業物聯網應用 覺文郁 / 虎尾科技大學校長
11:30-12:10	【主題演講】工業AI和工業互聯網未來趨勢分析 李傑 / 美國辛辛那提大學教授
12:10-12:30	【主題對談】未來製造工作型態 主持人：莊國欽 / 台灣區機械工業同業公會榮譽理事長 對談貴賓：所有主講人
主題二：積層製造	
時間	議程/講師
13:00-13:30	來賓報到
13:30-14:10	【主題演講】未來製造業的高端加工技術解決方案 Neun Harald / DMG MORI 營運長
14:10-14:50	【主題演講】The Evolution of Metal Additive Manufacturing: Leveraging the Machine Tool Infrastructure Pascal Pierra / Optomec 亞太區總監
14:50-15:20	【主題演講】增材智造實現快速生產 楊奇杰 / 馬路科技大中華區銷售經理
15:20-16:00	【主題對談】洞悉金屬3D列印未來發展 主持人：路怡珍 / 數位時代科技主播
16:00-17:00	德國工藝享譽國際—德國工具機產業發展新趨勢

主題三：航太智慧製造	
時間	議程/講師
09:00-9:20	來賓報到
09:20-10:00	【主題演講】駕馭高動態加工技術的開創性解決方案 Peter Topol / 海德漢資深產品經理
10:00-10:40	【主題演講】實現工業4.0—與西門子共創數位未來 Tino Hildebrand / 臺灣西門子副總經理
10:40-11:20	【主題演講】數位化協作與創新—啟動航太製造的工業復興! Rémi GERMAIN / 達梭系統全球策略聯盟副總裁
11:20-12:00	【主題演講】Advanced manufacturing technologies Cyrille SCHWOB / 空中巴士公司亞太區總監
12:00-12:30	【主題對談】變革中的製造業—預見未來五年 主持人：胡竹生 / 工研院機械與系統研究所所長 對談貴賓：所有主講人
主題四：汽車製造業變革	
時間	議程/講師
13:00-13:30	來賓報到
13:30-14:10	【主題演講】智慧製造全新局面來臨·工業機器人的創新技術及應用 鍾鴻鈞 / ABB區域經理-服務銷售 (東南亞及台灣)
14:10-14:50	【主題演講】CNC Systems for Factory of the Future 陳俊隆 / 台灣博士力士樂股份有限公司工廠自動化協理
14:50-15:20	【主題演講】實現工業4.1的智慧工廠自動化 鄭芳田 / 成功大學智慧製造研究中心講座教授兼主任
15:20-16:00	【主題對談】改革正在加速·我們準備好了嗎? 主持人：路怡珍 / 數位時代科技主播 對談貴賓：所有主講人
16:00-17:00	德國工藝享譽國際—德國工具機產業發展新趨勢

\*主辦單位保留議程變更及參加資格審核之權利  
\*現場提供中英文口譯

## 活動嘉賓

**Bernhard Meyer**  
SAP Global Solution Manager, Industry Business Unit, Industrial Machinery & Components (IM&C)



**Neun Harald**  
DMG MORI 營運長



**Peter Topol**  
海德漢資深產品經理



**胡竹生**  
工研院機械與系統研究所所長



**劉新正**  
ITTS東捷資訊服務副總經理



**Pascal Pierra**  
Optomec 亞太區總監



**Tino Hildebrand**  
臺灣西門子副總經理



**鍾鴻鈞**  
ABB區域經理-服務銷售 (東南亞及台灣)



**覺文郁**  
虎尾科技大學校長



**楊奇杰**  
馬路科技大中華區銷售經理



**Rémi GERMAIN**  
達梭系統全球策略聯盟副總裁



**陳俊隆**  
博士力士樂股份有限公司工廠自動化協理



**李傑**  
美國辛辛那提大學教授



**路怡珍**  
數位時代科技主播



**Cyrille SCHWOB**  
空中巴士公司亞太區總監



**鄭芳田**  
成功大學智慧製造研究中心主任





## 全球工具機產業 呈現新一輪回升

**根**據Gardner統計的年度全球工具機消費資料顯示，2017年全球24個主要工具機生產和消費國家和地區的工具機消費總額約為735.1億美元，同比增長5.1%。

其中，生產總額約為823.1億美元，同比增長6.3%；進口貿易總額約為320.8億美元，同比增長6.1%；出口貿易總額約為408.8億美元，同比增長8.5%。

全球工具機消費、生產和進出口貿易均呈現小幅增長，全球製造業開始呈現回升，由此將帶動全球工具機消費呈現新一輪的週期性回升。

從工具機主要消費國（地區）看，工具機消費額排名前十的國家和地區占到該項消費額統計總數的80.7%，工具機消費額排名前五的國家和地區占到該項消費額統計總數的71.3%；其中，中國大陸地區工具機消費金額達299.7億美元，占比為36.4%；第二名和第三名分別為81.4億美元和67.9億美元，占比分別為9.9%和8.2%。

從全球主要國別及地區的消費金額增長情況看，2017年全球工具機消費前十名的國家和地區均呈現較明顯的增長，僅日本同比減少1.8%，日本工具機消費負增長主要是由於其國內對進口的負增長導致，進口同比減少8.2%，這與日本工具機自給能力很強和日本製造業下降等因素有關。

從全球主要國別和地區的工具機生產金額增長情況看，2017年全球工具機消費前十名的生產均呈現增長態勢，這反映近期全球工具機消費呈現復蘇趨勢，但墨西哥、加拿大和印度的生產金額增幅較小。

在進出口貿易方面，2017年全球工具機消費前十名中，中國大陸、美國、德國、義大利、韓國、墨西哥和臺灣呈現進口和出口同時增長，這裡包括東亞、北美和歐洲等地區的主要製造業和工具機消費市場，全球化消費需求呈現復蘇跡象。另外，印度進口增長顯著，但出口呈現大幅下降，加拿大進出口均呈現下降，這主要與其經濟結構和運行不穩定有關。

來源: Gardner報告



## 工業4.0 產業市場將於2023 年達到2,140 億美元

**根**據美國HSRC 的調研報告，預計到2023 年，工業4.0 產業市場規模將達到2.14 億美元。

目前工業4.0 的市場競爭基本由全球科技巨頭主導，包括谷歌、惠普、三星、IBM、NEC、微軟等。他們在工業4.0 產品的研發、併購、商業化和內部使用上投入了數十億美元。此外，這些公司還通過收購小型的科技公司，特別是在人工智慧領域，以加強他們的工業4.0能力。

工業4.0 擁有巨大的潛力。智慧工

廠允許滿足單個客戶的單個需求，這意味著即使是一次性的產品也可以獲利。在工業4.0 中，動態業務和工程流程允許最後一刻對生產進行更改，並且能使工廠能夠靈活應對供應商中斷和出錯等問題。

在製造過程中提供端到端透明性，促進優化決策。工業4.0 還將帶來創造價值的新方式和新商業模式。它將為新創企業和中小企業提供發展和下游服務的機會。

工業4.0 的競爭不僅僅取決於技術

或提供最好的產品；它還涉及收集適當資料，將其結合起來提供最佳數位服務，並利用這些資料為自己謀利的能力。那些知道客戶想要什麼，並能夠預測消費者需求的公司，將獲得競爭優勢。

主要的贏家可能是那些控制“工業4.0 平臺”和各種軟體層的公司，平臺將各種設備、資訊和服務整合在一起，只有得到這一平臺，其他公司才可能建立自己的產品。

來源:《國際金屬加工商情 - 亞洲版》



台北南港展覽館1館1F  
Booth No. **I0316**

**DISCOVER MORE WITH MAZAK™**



INTEGREX i-200S



INTEGREX e-420H-S



QUICK TURN 200MA



VCN-430A



QTG-50 SG

**Mazak**  
Your Partner for Innovation



台灣美捷科股份有限公司

www.mazak.com.tw





# 新型感測器技術應用於現代機器人

**控**制和通訊 IC 的發展在實現下一代的機器人中起到重要作用。然而，這些複雜的現代機器人的核心是許多新的、小型化和低成本的傳感技術的出現與融合。對實現下一代機器人至關重要的幾項關鍵感測器技術包括磁性位置感測器、存在感測器、手勢感測器、力矩感測器、環境感測器和電源管理感測器。

## 磁性位置感測器——機器人的革命中的幕後英雄

在當今消費、專業服務、社交，甚至是工業機器人中最為普遍的感測器技術之一是磁性角度位置感測器積體電路 (IC)。當前，消費、專業服務或社交機器人的每個關節幾乎都用到兩個或更多的磁性角度位置感測器 IC。每個運動軸或關節旋轉需要使用至少一個磁性角度位置感測器。當今的許多機器人都採用小而強大的無刷直流電機 (BLDC) 來移動機器人的關節和四肢。為了正確驅動電機，需要知道電機的當前位置。

磁性角度位置感測器 IC 越來越廣

泛地用來為移動關節的電機控制器提供電機換向回饋。此外，機器人關節的閉環電機控制也需要關節齒輪的角度位置回饋。因此在機器人關節的每個運動軸上需要兩個磁性角度位置感測器。例如，當機器人的腳踝需要同時進行前後和轉動兩個軸方向的運動時，總共需要使用四個磁性位置感測器。由於每個關節的這種成倍需求，以及大多數機器人所需要的關節數大大增加，磁性角度位置感測器為何如此大量地用於當今最新推出的機器人中就顯而易見了。

## 為什麼選擇磁性角度位置感測器 IC?

於之前用於機器人關節中的競爭性的位置感測器技術相比，當今最新的磁性角度位置感測器 (如艾邁斯半導體的 AS5047P 和 AS5600L) 具備多項優勢。新型磁性位置感測器 IC 提供高解析度和重複精度。此外，由於製造採用了 CMOS 矽技術，與競爭性位置感測器技術 (如光電編碼器和旋轉變壓器) 相比，它們所需的功率、

重量和體積都非常小。此外，磁性位置感測器 IC 可以在非常惡劣的環境中工作，包括極端溫度和骯髒多塵的環境。有些磁性位置感測器 (如艾邁斯半導體的全系列磁性位置感測器 IC) 甚至可以免受機器人工作環境中常見的雜散場干擾。最後，與低成本社交/玩具機器人的傳統伺服電機零組件中常見的電阻電位計不同的是磁性位置感測器是非接觸式的，沒有運動的機械部件，所以不會磨損。正是由於所有這些內在優勢，磁性角度位置感測器在當今的消費、專業服務和社交機器人，現在甚至在工業機器人中都被廣泛採用。

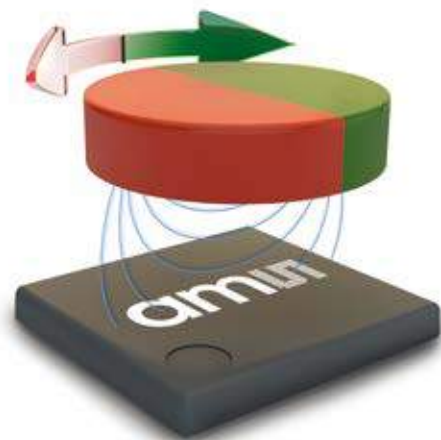

採用圓盤形磁體的磁性位置感測器

## 存在感測器

現在，數項存在感測器技術正被集成到當今的機器人中，它們的資料會融合在一起，用於為機器人提供空間視覺感知以及物體檢測和避讓。2D 和 3D 視覺立體攝像頭在當今的新型消費和專業服務機器人都很常見。然而，新型的先進感測器技術，如包括基於飛行時間的光檢測和測距 (LIDAR)

感測器，也越來越多地部署到機器人當中。LIDAR 為機器人提供其工作空間及周圍環境的高解析度 3D 測繪，以便它可以更好地執行任務並四處移動。

同樣，超聲波感測器也正被用於存在感測。與用於汽車倒車時的安全報警系統感測器相同，機器人中的超聲波感測器用於檢測附近的障礙物，以防撞到牆壁、物體、其他機器人和人。另外，它們可以在機器人執行主



**源利電磁工業股份有限公司**  
Uni Magnetic Industrial Co., Ltd  
www.unimag.com.tw



TaiNEX 2 R0908



**強力磁鐵過濾機**  
磁力高達5000高斯，過濾精度可達10μ！  
完全無耗材，因此只需一台即可滿足過濾的需求。  
適用弱磁性金屬、油性、水性切削液。

The magnetic force is up to 5000 gauss, makes the filtration efficiency up to 10μ! No consumption at all. Applicable to weakly ferrous metal, oil-based or water-based coolant.



**移動式廢渣回收機**  
不需接電，不需停機，清潔時間短，體積輕巧的移動式廢渣回收機。  
適用金屬屑、非金屬屑、油性、水性切削液。

None-demands in extra electricity and machinery stoppage, cleaning time shortened. This light and mobile scrap recycling machine is suitable for scraps of metal, non-metal, and oil / water cutting fluids.

**MAKING EXCEPTIONAL FILTERS FOR EVERY INDUSTRY.**



+886-4-781 0900  
unicoltd@ms26.hinet.net  
彰化縣鹿港鎮彰濱工業區  
工業西六路23號

+86-021-5436 5295  
zhanghua@unimag.com.tw  
上海市徐匯區宜山路691弄19號102室



**ENERGY SAVING**  
SAVES 15% CUTTING FLUID



**HIGH PRECISION**  
HIGH FILTERING PRECISION



**ULTRA CLEAN**  
95% IMPURIFIED RIDDANCE





SINCE 1977

# UFO

One shank for 400 inserts



**Patent Tool Agent Wanted**



TWTC Hall1, A0424





























**YIH TROUN ENTERPRISE CO., LTD.**  
www.cut-tools.com.tw

+886-2-8521-3035  
ytservice@cut-tools.com.tw  
No. 1, Lane 403, Hua-Cheng Rd., Hsin-Chuang,  
New Taipei City 24253, Taiwan



30

第三天 | 2019年3月4日-9日



要功能任務時發揮作用。因此，超聲波感測器在近場導航和避障中起著重要作用，最終提高了機器人的整體性能和安全性。

但是，超聲波感測器的作用距離有限，大約為一釐米到幾米，而最大角度錐體約為 30 度。它們的成本相對較低，並在近距離範圍內具有較高的精度，但隨著距離和測量角度的增加，其精度會下降。它們也易受溫度和壓力變化的影響，還會受到使用調諧在相同頻率的其他機器人的超聲波感測器的干擾。儘管如此，當與其他存在感測器結合使用時，它們還是可以提供實用可靠的位置資訊。

當所有這些存在感測器（2D/3D 攝像頭、LIDAR 和超聲波）資料融合在一起時，正如我們現在開始在高端消費/專業服務機器人和工業機器人中所看到的，這些機器人能夠出色地實現對周圍環境空間感知，移動並執行更複雜的任務，而且不會令自己、人或其周圍環境受到損害。

### 用於人機交互的手勢感測器

手勢感測器也越來越多地集成到當今一些最複雜的機器人中，用來輔助提供使用者介面命令。手勢感測器技術包括光學感測器和機器人操作員佩戴的臂帶式控制感測器。

利用光電手勢感測器，可以訓練機器人識別特定的手部動作，並按照特定的手勢或手部動作來執行某些任務。這些手勢感測器為家中或醫院裡的殘疾人和溝通障礙人士，以及智慧工廠提供了很多便利。

佩戴了臂帶式控制感測器的操作員可以與協作式工業、醫療或軍事機器人溝通，並控制機器人，使其按照操作員的手臂運動方式和手勢來執行和/或模仿某些任務。例如，雙臂均佩戴臂帶式感測器的外科醫生可以控制遠端醫療機器人的雙臂進行手術，而它也許遠在地球的另一端。

### 力矩感測器

力矩感測器也越來越多地用於下一代機器人中。力矩感測器不僅用於機器人的末端執行器和夾持器，而且還用於機器人的其他部位，例如軀幹、臂部、腿部和頭部。這些特殊的力矩感測器用來監測肢體的快速運動、檢測障礙物並為機器人的中央處理器提供安全報警。例如，當機器人手臂中的力矩感測器檢測到由於手臂撞擊到物體而引起的突發和意外的力時，其控制安全軟體可以使手臂停止運動並縮回其位置。

力矩感測器也與存在感測器以及其

他安全監測感測器（如環境感測器）共同協作，以提供總體安全區域監測功能。

### 環境感測器

各種環境感測器也正在進入工業和消費機器人領域。環境感測器包括檢測與空氣品質有關的 VOC（揮發性有機化合物）感測器、溫度和濕度感測器、壓力感測器，甚至可檢測光照存在的感測器。這些感測器不僅能幫助確保機器人一直安全有效地工作，還能讓機器人周邊的人們察覺到不安全的環境條件。

### 電源管理感測器

電源管理感測器也集成到當今的自動化機器人中，用來幫助延長機器人的工作時間，並確保鋰電池（當今自動化機器人中最常見的電池）充電或耗電時不會過熱。電源管理感測器還用於機器人關節電機的穩壓與功率和熱管理。所有板載機器人器件（如微處理器、感測器和執行器）都需要低紋波電源和穩壓，以確保它們高效、正確地工作。

用於機器人電源管理的最新感測器解決方案包括用於電池放電和充電的庫侖計算的感測器、用於穩壓器的精



帶有磁性位置感測器的機器人手臂

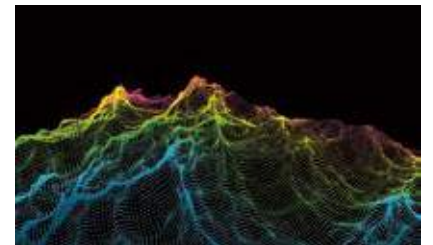

LIDAR 測繪

準可靠的過溫監測感測器，以及電池管理設備中的電流感測器。

得益於所有這些新型創新的感測器技術的集成和融合，當今最新的機器人可以更獨立和安全地運行。此外，由於計算能力、軟體功能和人工智慧的大幅提高，並配合上這些新型感測器技術，下一代機器人可以更輕鬆地用於支援各種各樣的應用。而且，它們可以比原先的機器人更精準、更快地執行任務。最後，它們可以在更廣泛的家庭、商業和製造環境中更獨立、更協作和更安全地運行與工作。■

來源：《工業設備商情》

MADE IN TAIWAN

**CHG** 詮豐精密工具股份有限公司  
CHUNG HONG PRECISION TOOL MFG.

▶ 線性傳動的新領域

www.chpt.com.tw

PAT.

Planetary Screw Assemblies  
行星式滾柱螺桿

**TIMTOS** 2019.3/4~3/9  
Nangang Hall 2, S0207

Kaohsiung	+886-7-6381281	chggauge@gmail.com
Taichung	+886-4-22421981	chggauge@gmail.com
China	+86-21-59136471	shqfpt@126.com
Thailand	+66-2-7504225	chgthai@gmail.com

**LCH**  
High Speed Eco Servo Press

**LCH** ECO SERVO

連傑油壓  
www.lch.com.tw  
3000

Energy Saving  
Noise Reduction  
Higher Production Rate

LCH-ES ▶

eco

72<sup>nd</sup> anniversary  
Press Expert

**TIMTOS**  
TWTC Hall1 1F D0501

**LCH** 連傑油壓工業股份有限公司  
LIEN CHIEH HYDRAULIC INDUSTRIAL CO., LTD.  
No.97, Baoxin St., Xizhi Dist., New Taipei City 22173, Taiwan  
Tel: +886-2-8648-3000 ext.320 Fax: +886-2-8648-2000  
lienchieh@Lch.com.tw www.Lch.com.tw



參展商採訪

# 富偉：快速換模系統再度運用突破性自動化科技

富偉精機股份有限公司專注於開發全廠自動化快速換模系統，自1987年以來以創新、成熟的自動化設備供予工具機以及塑膠機械領域更高效、節省人力以及更安全的加工型態。富偉在TIMTOS 2019帶領買主一同進入富偉的自動化旅程，探索他們秉持的自動化信念、激盪創新並開啟未來的可能性。

富偉快速換模系統適用於沖床、油壓機、射出機、壓鑄機等機臺，內容包含夾模器、舉模器、移模臂、操作箱以及動力來源的氣動泵，使用富偉快速換模，可以讓原本繁瑣浪費時間的鎖模過程變得簡單快速，這大大的減少換模過程中所使用的人力、困難度，也大大的增加換模過程的安全性，減少工安意外。

富偉快速換模系統，是使用油壓驅動，比起傳統的螺絲鎖模，更加簡易安全。並且富偉保證，在停電狀況下，也能夠48小時不洩壓，保障人員、機臺安全。

富偉產品口碑有目共睹，在臺灣、中國，皆是第一家專業於快速換模的製造商，並且在這分秒必爭的時代，富偉不只注重品質，也注重服務。

富偉的強項是客製化不同產業的系統，除了與主要工具機、沖床的客戶

合作之外，他們近年來也幫助全球塑膠原料大廠執行標準化廠房的項目。其中，富偉扮演著規劃自動換模、快速夾持的角色來幫助大廠達到更安全的作業環境。換模其實是一道非常耗時的環節，且依照當前的科技趨勢來說，金屬切削以及塑膠射出速度都已經達到階段性的極限了，但在換模工序上的耗時卻遠遠的落後其他工序的速度標準。越大的機台需要的換模時間越長，工廠也需要配置更多的設備如天車或堆高機來進行大型設備的換模。因此，自動換模對於全球大型生產商是充滿吸引力的。

今年富偉在TIMTOS 2019針對快速換模以及大行程夾模器進行展示，這些技術目前在全球市場上屬於高門檻技術，富偉希望可以將這個技術導入臺灣工具機市場。再加入了這項高效率的快速換模後，臺灣的金屬加工可望倍增許多優勢。

1. 大行程的TD夾模器：大行程的TD夾模器是現在夾模器效率的2倍，在維持同一體積下，改變了結構，也使應用方面的活度更廣泛，無論是金屬沖床或是塑膠射出機都可應用。

2. 升級加工機上的快速換模系統：富偉積極的為快速換模系統進行升級，

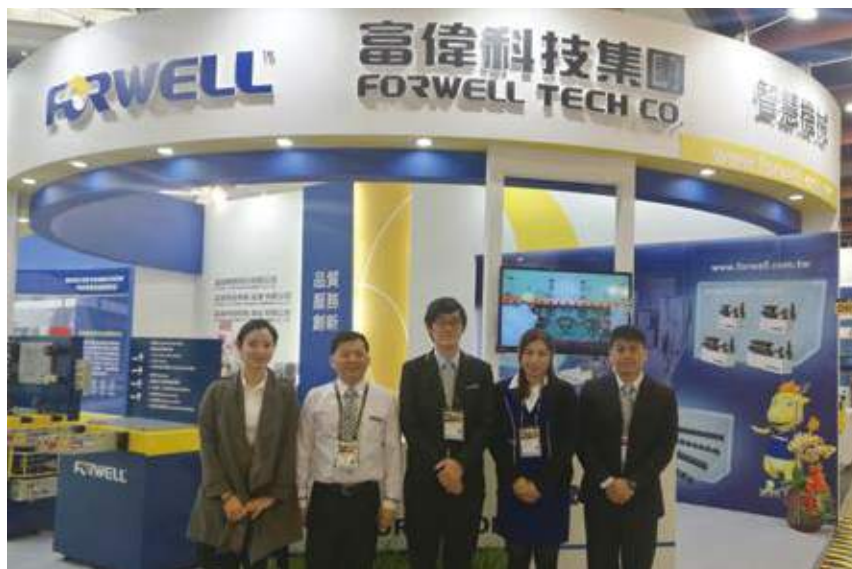

為金屬切削的用戶增廣應用端，簡化替換加工時需要使用虎鉗進行手工換模的程序。以模組化的設計將快速換模系統結合到工具機中，可以不用停機，便預先安排下一批工件的加工程序。也就是說在上一批製程未結束前，機臺就可以先預備下一批的加工程序。富偉過去進行過許多金屬成型領域的自動化系統，現在也開始針對更多元、趨勢變化快速的金屬切削領域發展。TIMTOS將會展示這些升級的新研發。這些科技走在全

球的前端，富偉也希望為客人產生實質的幫助。

富偉已經是自動化領域的指標性領導者，今年TIMTOS 2019 歡迎參觀萬眾矚目的富偉前衛自動化科技。

**富偉精機股份有限公司**  
電話：+886-4-8345-196  
傳真：+886-4-8345-197  
郵箱：forwell@forwell.com  
網址：www.forwell.com  
攤位號碼：D0530

# 瀧澤科技：卓越兼具智慧的機械精神

瀧澤科技將邁入50週年，他們成功的將日本瀧澤100年技術DNA融入工作母機製造工藝傳播至全世界的製造業重鎮。瀧澤科技努力將瀧澤品牌在亞太地區、東南亞地區、歐洲與美國發揚光大。瀧澤科技2018年創下營業額33億的佳績，持續研發新機種滿足客戶需求，為客戶創造更有價值的品質與生產效益。今年，瀧澤科技在TIMTOS 將以新一代的車銑複合機、立式車床席捲TIMTOS盛會。

本刊：TIMTOS展出的設備主要特色為何？

瀧澤科技：瀧澤在TIMTOS 2019展出三項新設備，分別為LX-2500M 新世代高剛性車銑複合機、EX-2000YS 新世代高精度車銑複合機、以及VTL-950 高性能立式車床。這些設備主要應用於石油能源產業、航太零件加工領域。瀧澤優化了主軸臺和刀塔，並且著重於提升機臺總體效率的訴求。其中，包含機

臺的移動速度、換刀速度提升、剛性提升以及熱變位的改善都是瀧澤機械不斷尋找更佳機械表現的重要加工指標。

以下為本次瀧澤科技在TIMTOS的設備特色：LX-2500M 新世代高剛性車銑複合機主軸採用內藏主軸設計以達更精密的加工精度。軸向移動速度提升50%，同時提升加工速度；此外，機臺結構熱對稱設計讓加工件能夠獲得更安定的尺寸精度；而硬軌軌道跨距與寬度優化則強化了機臺的結構設計。加工行程優化能夠增廣加工範圍，而也已全新的板金外觀為LX-2500M創造了簡潔俐落感。

EX-2000YS 新世代高精度車銑複合機因採用內藏主軸設計主軸進而達到更精密的加工精度，軸向移動速度同時提升50%、並且藉由正副內藏主軸設計增強Y軸機能。瀧澤也積極將模組化設計的概念運用於此機臺中，代表一臺設備同時能展現多種機臺型態。並且以更緊湊的機臺尺寸達到最佳的生產能力與佔地面積的比例。第三台設備為VTL-950

高性能立式車床。VTL-950擁有高剛性的結構設計，且全機軸向採用硬軌設計。採用大尺寸的離合齒輪與刀塔設計來滿足重切削之需、並且全機採用a系列馬達以達高精度的馬達設計。

瀧澤不間斷的推出複合機，確保用戶在最受矚目的產業中永續發展。憑藉著過去在國際航太製造廠合作的經驗，在美國航太產業賣出幾十臺，以精準的加工技術製造發動機。此外，近年來瀧澤在電動汽車產業特別受用戶歡迎。優點是增廣加工範圍、產業應用、將多臺機械的效能整合於單機裡，節省空間、提升效能及效益。

本刊：請分享瀧澤未來的發展計畫

瀧澤科技：未來的工具機除了注重複合化、在結構設計上會朝向模組化進行。模組化將賦予工具機更簡易的維修與組件升級空間，且會加速工具機在創新科技上的推進。瀧澤科技在這個主題上不斷嘗試更耐用、更快速以及更人性化智慧化的加工方式。

**台灣瀧澤科技股份有限公司**  
電話：+886-3-4643-166  
傳真：+886-3-4643-674  
網址：www.takisawa.com.tw  
攤位號碼：K0108

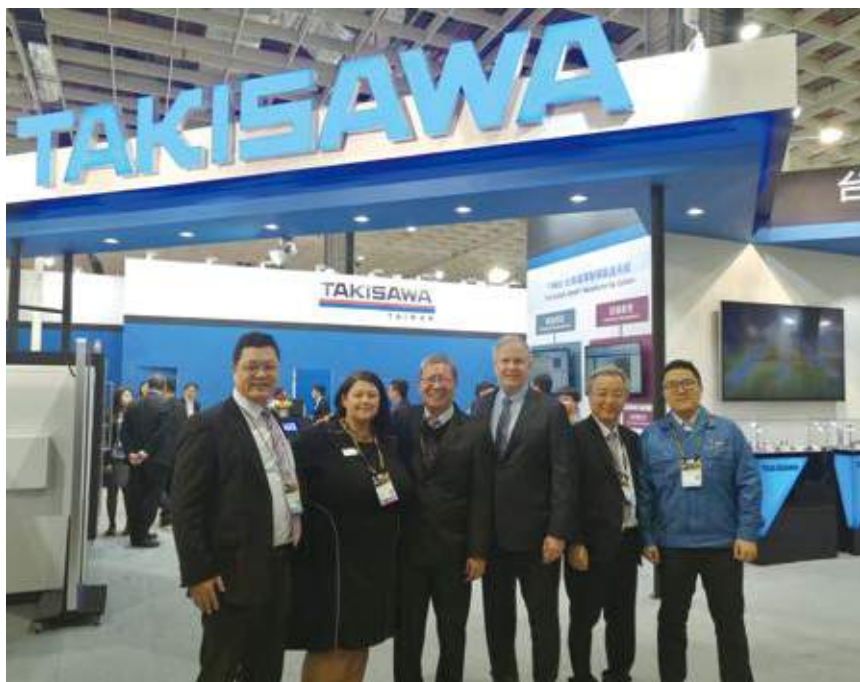



## 友嘉：滿足智能化生產設備需求



新設計能力，自主加工生產，以及嚴格的品質把關。“為了確保友嘉機器符合全球每一位客戶的需求，我們採用一貫化的加工生產體系。廠內擁有全系列精密加工設備，為友嘉卓越的製造能力提供穩固的基礎。為滿足客戶加工需求，友嘉業務、研發單位結合市場回饋之訊息及技術經驗，持續進行產品改善與開發，並嚴格要求進

料檢驗、組裝品質，所有機臺均經嚴格的雷射檢測，保持機臺品質水準穩定。”洪崇育先生總結道。

**友嘉實業股份有限公司**  
 電話：+886-4-2359-4075  
 傳真：+886-4-2359-4873  
 郵箱：sales@feeler.com  
 網址：www.feeler.com  
 攤位號碼：J0330

作為全球第三大工具機集團，友嘉集團（FFG）在本屆TIMTOS展上將展出一系列產品，以滿足各產業加工以及用戶對智慧化生產設備的需求，其中亦包括主攻航太、精密模具等市場的五軸加工中心機UB-660。

據友嘉協理洪崇育先生介紹，五軸加工中心機UB-660主要定位在航太業、汽車業、能源業、精密模具業等市場，具有以下特點：

1. T字型超高剛性底座，結合移動式立柱式結構，在大型與重型工件有出色的動態性能和高精度加工。
2. 擺頭式（B軸主軸）配水平旋轉工作臺（C軸）工件沒有翻轉效應，可確保加工件的精度與品質。
3. 大扭力內藏式主軸，轉速12000rpm、扭力88.3Nm、功率37Kw。
4. 適用長型與複雜工件，以最小的佔地空間具備最大化的加工效益。
5. 複合式工作臺，僅需一次裝夾即可快速完成，提升效率並節省加工時間。
6. 油溫冷卻系統採用變頻式水冷卻機，提供主軸/擺頭/轉臺保持穩定於最佳溫度運轉，展現高效率與高精度加工特色。
7. 兼具高剛性與高精度於一體的五軸立式加工中心機。

洪崇育先生表示，多年來，友嘉工具機以性能卓越可靠贏得全球客戶的高評價。此種榮譽可歸諸於友嘉創

**精密、卓越工具機领航家** 龍門、五面、五軸專業製造

**SDV-HLA系列**  
 CNC高精度龙门加工中心机 with 自动分度万向铣头模组  
 直结式主轴10000rpm, 两段变速行星式齿轮箱, 最大输出扭力可达907/770Nm

特色：高刚性正交式自动方向铣头  
 BT-50, 3000rpm,  
 C轴自动最小定位分度5°(1°), ±270°  
 A轴自动最小定位分度5°(1°), ±90°  
 重切削移除率最高可达640cm³/min

**S5A-4732HH (TIMTOS展示机)**  
 CNC五轴龙门加工中心机 - 重切削型  
 特适用于钛合金、不锈钢或其他难削材料之多轴同动加工

**TIMTOS 2019** Mar 4-9  
 27th Taipei Int'l Machine Tool Show

**Booth No. P0814**

**新穎機械工業股份有限公司**  
 台中市神冈区庄後里大圳路53号  
 Tel: +886-4-25628000 / Fax: +886-4-25621493  
 E-mail: sigma.cnc@msa.hinet.net

www.sigmacnc.com.tw





參展商採訪

# 馬波斯：量測技術世界領導者

**馬**波斯由Mario Possati先生 (1922-1990) 在1952年創立於義大利波隆那：他的發想是製造第一具用於研磨過程中，檢查工件的電子量測設備，以期改善工具機所加工產品的品質與產量。

公司於80年代中期進軍亞洲市場，最開始的兩個國家分別是中國和韓國。馬波斯目前直接在20多個國家建立了自己的銷售和服務機構，並在另外十幾個國家建立了代理商和經銷商網絡。

今日馬波斯已成為量測技術世界領導者，他提供的產品，小自個別量測零組件，以迄量測機統包方案，或全自動化量測線：所有在加工現場生產改善與品質控制之所需。

馬波斯的使命是在機械加工期間和之後提供在車間使用的精密計量設備。設備的設計和製造適用於各種處理中和後處理的應用，並可在最惡劣的車間條件下保證產品性能。

馬波斯的主要客戶包括：工具機製造商，向其客戶和最終用戶銷售已配備馬波斯測量系統的機器；汽車行業及其分包商；測量發動機傳動、噴射、車身、玻璃等部件；航空航太、軸承、玻璃、電動機、電器和耐用消費品行業；儀錶和固定裝置製造商。馬波斯可根據各種生產控制要求提供全球化的定制或標準解決方案。

持續成長，當然是馬波斯集團的策略目標之一。馬波斯以自身成長為基礎，持續投資於創新技術與新產品。這除了組織內部的成長，也透過對外部公司的合併。

自2000年，馬波斯展開對於健全、結構完善的公司的合併計畫。這些公司，每一家均在各自相關產業提供頂級的產品（例如監控方案、產品組立與產品測試），所有這些公司都是各自相關產業的領導品牌。但是限於規模，他們只能進行區域性的營運；在加入馬波斯



集團後，透過馬波斯全球組織網絡，他們均能獲得極大收益。

反言之，透過這些合併，馬波斯拓展了產品與解決方案的範圍。今日集團擁有超過3,500名直屬員工；其中有1,300人工作於義大利總部，而在中國約有800名員工。

無論是過去的成功，還是未來的發展，馬波斯的基石是遵循一貫的創業理念——無論用戶在任何地方都能得到馬

波斯最好的銷售支持和售後服務；在研發上不斷投入，為用戶提供最合適的解決方案；努力提高客戶滿意度，並以此作為衡量我們工作的標準。

馬波斯精密股份有限公司

電話：+886-4-2262-2340

傳真：+886-4-2262-2402

郵箱：sales@tw.marposs.com

網址：www.marposs.com

攤位號碼：南港2館 P0320



## HOSEA HOSEA PRECISION CO.,LTD.

Tel: 04-2531 9551 <http://www.hosea-world.com>  
Fax: 04-2535 5734 Email: sales@tanshing.net

### CNC ROTARY TABLE

**TIMTOS 2019**  
Mar. 4-9  
27th Taipei Int'l Machine Tool Show  
南港展覽館二館4樓 R0818



HOSEA PRECISION CO., LTD. has been exporting 5 Axis rotary tables for over 15 years and we are the leading supplier of this type of export controlled product.

Over 300 5 Axis Rotary Tables Per Year exported from our Taichung manufacturing facility.

We are the **Largest Supplier** of 5 Axis rotary tables in Taiwan.

Hosea becomes first Taiwanese rotary table manufacturer to obtain AS9100D certificate



### ACR-4040、APC-400

#### Higher Productivity

Through high-speed exchange of the tray to reduce exchange time from 15 sec to 6 sec.

#### More Concise Mechanical Design

Only through the cam mechanism, you can complete tray ascending, descending, and other actions.



**TIMTOS 2019**  
Mar. 4-9  
TAIPEI NANGANG Exhibition Center, Hall 1  
BOOTH NO. 10408

E-830

E-530

P-501LA

## I TECH SAW

### SAW YOUR IDEA

**A sawing database with 60000 entries**  
**Decrease defect rate** Increase production speed

www.everising.com  
evrs@everising.com.tw  
+886-4-2359-3178



# 只需1秒加入,與目標潛在買家聯繫

超競爭時代

要使用哪種方式觸及目標買家?

## 內容決定品牌影響力

為什麼選擇故事行銷?

在當今的資訊時代,各類資訊鋪天蓋地。在浩如煙海的資訊中,如何使你想被人看到的資訊不被淹沒?這就需要有好的故事行銷來突顯你的產品了。除了好的內容之外,還需要有良好的平臺和管道來幫助你迅速推廣,獲取有效銷售資源。

**CREATE  
PROMOTE  
ENGAGE  
OPTIMIZE  
STRATEGY  
ANALYZE  
MARKETING**

全媒體行銷整合策略幫助您建立溝通的橋樑、找到中國、東南亞以及全球潛在買家,並提升品牌價值

### 專業編輯團隊

由榮格的專業編輯與攝影團隊為您定制內容(文章X影片)。

### 正確管道

內容發佈於社群媒體、網站、電子快訊與雜誌

### 目標受眾貫穿全產業鏈

在適當的時間,以適當的媒體形式,接觸到正確的人,真正觸達產業鏈中的決策者

通過4大管道,迅速傳遞您的故事內容,有效觸及9大產業的目標買家

覆蓋9種產業  
+  
2大市場

★醫療設備、金屬加工、工業鐳射、感測器、工業機器人、汽車、航空製造設計、智能製造與工業設備產業  
★中國與東南亞市場

4大宣傳管道



平面與電子版

紙感閱讀  
工業雜誌

174,000+  
訂閱戶



分享再分享  
社群媒體

45,000+  
粉絲



主動出擊  
電子快訊

317,000+  
訂閱戶



拉式推廣  
網站

306,000+  
月均獨立訪客



立即聯繫  
獲取專案服務優惠價格  
sydneylai@ringier.com.hk  
886 23297318

通過案例分享讓您更了解



金豐機器工業股份有限公司



## 產品報導

### 減速機

TK系列

功能：適用於鋼鐵廠、造紙廠、橡膠廠、紡織廠及重馬力、負荷大的工廠特性：

1. 減速機內之齒輪元件是採用低碳合金鋼棒材或鍛造再經正常化處理，使工作物內部組織較緊密，增強韌性。

2. 減速機之齒輪元件是採用特殊25度壓力角齒形。因為齒根較厚所以在運轉時能承受更大的負荷及更大的衝擊。

3. 減速機之齒輪元件經滲碳處理後。齒面再經由高精度的齒輪研磨機研削。可提高齒輪面的臨合率，而且可以降低噪音。並提高工作效率及齒輪減速機之壽命。



天益齒輪股份有限公司

電話：+886-3-5970-206

傳真：+886-3-5970-210

郵箱：tien0206@ms15.hinet.net

網址：www.tienyigear.com.tw

攤位號碼：G0231

### 臥式加工中心機

型號：MH-500A

功能：專為中小型零部件設計的加工機

MH-500A中小型的機身，適合汽車配件及中、小五金零件加工。自動交換工作臺擁有快速的交換速度，減少工件設定非切削時間，精密錐型定位確保工作臺交換穩定性。

特性：

1. 立柱採用對稱型的雙重壁的結構設計，可避免因溫升導致熱變異進而影響切削精度。

2. 採用高強度補強肋底座，有效吸收加工的震動，及提升設備的切削穩定性。

3. 主軸採用短鼻式設計，依主軸最大剛性規劃結構，頭部依有限元素分析採用最佳結構規劃，並在前端加長主軸鎖固面，方便客戶加工深孔。

4. 刀庫安裝於上方使干涉區少，刀臂短讓換刀速度更快。

5. 機械結構緊湊，最小的佔地面積使工廠的坪數能提高。

馬特工業有限公司

電話：+886-4-2525-0480\*202

傳真：+886-4-2525-7747

郵箱：claire@macocnc.com

網址：www.macocnc.com

攤位號碼：K0322



### 超高速節能壓機

型號：LCH-ES

功能：透過LCH獨家油壓系統，在高精度及精密控制下，此設備可以在節能減碳下實現多種成型工法，包含鍍金成型、複合材料成型 (SMC / BMC / GMT / CFRP)等等。



特色：

1. 精密伺服系統提高精度

2. 生產效率提升

3. 能源效率提升

4. 降低噪音

連傑油壓工業股份有限公司

電話：+886-2-8648-3000

傳真：+886-2-8648-2000

郵箱：michael\_wang@lch.com.tw

網址：www.lch.com.tw

攤位號碼：D0501

### 樹德刀具車

型號：TW-CT4BHA

功能：側邊可配置方孔掛版，可無限擴增增加手工具配件，荷重200KG，搭配TPR靜音輪。

特色：

1. 可放置4座刀套架，每座BT30\*10、BT40\*8、BT50\*6、BT63\*。

2. 刀具車前後端設有方孔掛板，使用者可以吊掛配件、定位板手、置物盒、瓶罐等。

3. 上方一側設有狹長型承盤，可供操作者放置使用中器械，上方另側設有不同大小排孔，可供起子或六角板手插置。

4. 底部設有大型承盤，可供放置較大型器物。

樹德企業股份有限公司

電話：+886-2-8780-9600

傳真：+886-2-2299-5200

郵箱：fa208@shuter.com.tw

網址：www.shuter.com.tw

攤位號碼：B0312



### 集中潤滑給油系統 - 電動脫壓式油脂系統



型號：MSK-10 FW

功能：使用馬達加壓方式定量加壓分配油脂到各出油點；搭配定量分配器針對各點之需求有效提供油脂潤滑。

特色：使用的是軟性油脂(黃油)作為潤滑劑，因其黏著度佳，其在注油過程與提供潤滑中不會快速流掉，含著於各培林或螺桿所需處，延長油品的潤滑效用，且因其特性無須連續的供油，可以更少量的油提供時間更長的潤滑需求。其產生的廢油汙染也更少。

永錕潤滑科技有限公司

電話：04-25284429

傳真：04-25242345

郵箱：chiba.tw@gmail.com

網址：www.chiba.com.tw

展位號：R0103

### 線/板材自動成型機

型號：YSM- CNC 39T

功能：根據客戶的產品需求，配合客製化模具去自動沖壓及成型量產。

特色：沖床最高承載400kN /成型單組承載最高80kN；

簡易的程式編輯及操作輸入；

三軸獨立伺服馬達:送線、沖床、成型；

可結合攻牙、焊接及配合組裝；

簡易快速換模；

歐規C.E.認證；

高投資報酬率：低成本、高效率。



逸陞機械有限公司

電話：+886-4-2337-5168

傳真：+886-4-2337-2962

郵箱：info@ysm.com.tw

網址：ysm.com.tw

攤位號碼：D0301

### 高進給雙面銑刀片

型號：CXBN

功能：金屬切削(舉凡鋼鐵、不鏽鋼、鈦合金、鎳基合金、複合材、銅合金及鋁合金皆能迎刃而解)

特色：

1. 適用於高速高進給的銑削

2. 高進給+4個切削角，同時節省成



本跟提昇效率

3. 高效能，低抗阻，專為低切削力而設計

4. 刀桿直徑最小16mm，最大吃深為1mm

萬事達切削科技股份有限公司

電話：+886-6-3840-386

傳真：+886-6-3840-387

郵箱：Davey@carbindex.com

網址：www.winstarcutting.com

攤位號碼：B0828

### INTEGREX AG Series

型號：INTEGREX i200 AG

功能：複合加工機中融入齒輪加工以及測量功能的Hybrid機型，共有3種 (Auto Gear) 的功能Skiving加工、滾齒刀加工、端銑刀加工。

特色：Mazak複合加工機中融入齒



輪加工以及齒形測量功能，對於複雜的工件；加工透過製程整合，能使機台數量減少，並節省人力，一次夾持就能夠完成；全加工，達到提高精度並省略定位過程，縮短準備時間，且透過機回饋；上測量的資訊，加工結果便可達到自動化。

台灣美捷科有限公司

電話：+886-4-2350-9811

傳真：+886-4-2350-9812

郵箱：Weichiao\_Liu@tw.mazak.com

網址：www.mazak.com.tw

攤位號碼：I0316

### 各式自動化點焊機

箱體補強架專用機、抽屜交換模專用機、箱體天地蓋專用機、抽屜單模專用機、冷氣外殼專用機。

詮興電機有限公司

電話：+886-4-2407-0658

傳真：+886-4-2407-0657

郵箱：welding@ms14.hinet.net

網址：www.wpitaiwan.com

攤位號碼：C0936



**精密型超高速擴張網機**

型號：JEC-XP-35-SF

功能：將金屬板材透過縱切和延展加工為菱形孔的板網，且不產生廢料，並形成堅固結構。

特色：久恩之精密型超高速擴張網機久恩維持一貫的高速穩定生產效率，特開發超薄型細微網孔高速生產需求，最快可以每分鐘1,800下，打出厚度僅0.1mm，網目細微至0.5 x 1.0mm的產品，多應用於導電相關產業。

久恩擴張網機以合理價格提供高品質及長久穩定效能的高產量，以普遍為業界日美澳大廠牌客戶所認可；我們同時也以擴張網生產者的立場，堅持提供客戶在機器使用者體驗和生產技術上的突破與創新。

久恩企業股份有限公司

電話：+886-7-3737-800

傳真：+886-7-3737-900

郵箱：enping.yang@junen.com.tw

網址：www.junen.com.tw

攤位號碼：C0832



**龍門銑床**

型號：DB/DS /FA系列

功能：適用於中大型零件加工，舉凡汽車、火車、風電、航空、石化、石油等等，皆適宜。多元化工件均適合，可依客戶需求化生產。搭配高剛性結構機身，可滿足客戶客制式加工工件需求。



特色：台灣首創X軸全正四軌設計，加配全齒輪式主軸頭，更以超強機械之結構。

高剛性及高穩定性。致力於研發高性能，高速全齒輪式主軸頭，CNC龍門式全齒輪傳動主軸頭。CNC龍門銑床，高精度，耐負重，高壽命，高信賴性！提昇業界競爭力。媲美歐日，著重客戶整體經濟效益。

合升精密機械股份有限公司

電話：+886-4-2638-0633

傳真：+886-4-2638-0733

郵箱：goushinsales@gmail.com

網址：gmt-cnc.com

攤位號碼：I0328

**伊吉斯車銑複合式車床**

功能：提供客戶在單機上可完成車削、銑、搪孔、鑽孔與攻牙等複合加工配置Y軸，副主軸及動力刀塔，可提供螺紋銑削，複雜的偏心銑削，鑽孔加工及背面加工。

特色：凡仕成/伊吉斯斜背式數值控制車床，是高剛性、高精度車銑多功能車床，全系列配置12刀動力刀塔與主軸C軸功能相結合，全系列機種搭配C1及C3等級螺桿以確保機器精度，由使用者端經驗提供，我機器於加工精度及剛性優於同質性產品，尤其是使用我司硬軌機型機器，在不鏽鋼材質工件做剛性攻牙工序，效果立現，亦因此成為汽機車零件製造商之愛用及支持。

凡仕成企業有限公司

電話：+886-4-2559-0525

傳真：+886-4-2559-0387

郵箱：catherine@first-chant.com

攤位號碼：G0454



**小龍門盒型雕銑機**

功能：我們的CNC雕銑機適用範圍從精密產品、銅電極、精密模、滴塑模、熱切模、刻模到小型的射出模具。

特別是這些加工需要極度平滑的表面，例如光學設備的表面，電子半導體及手機等。

特色：小龍門盒型結構並結合了堅固的盒型設計排除了當主軸在移動時所產生剛性不良問題此機台屬於暢銷機種由於本身的性能好、精度佳而在加工上有高效能精度表現、易操作、結構性完整、性能佳又加上機台售價經濟實惠。

秀豐機械股份有限公司

電話：+886-4-2279-2121

傳真：+886-4-2270-9039

郵箱：sales@surefirst.com.tw

攤位號碼：G0226



**Micro Electric Power-off Brakes**

極小型斷電煞車器

**HOT NEW ARRIVAL**  
Smaller in diameter than 20mm



Spring applied Brake  
微型彈簧式斷電煞車器

Permanent Magnet Brake  
微型永磁式斷電煞車器



CHAIN TAIL CO., LTD.  
仟岱有限公司 since 1984  
www.chaintail.com

**TIMTOS**  
2019.3/4~3/9  
Nangang Hall 2, S1414



No. 305, Lane 460, Sec. 1, Hsinan Rd.,  
Wujih Dist., Taichung City, 41462 Taiwan  
TEL: 886-4-23353024 FAX: 886-4-23354027

**IT'S ATTITUDE.**



Right tool for right job.

High speed cutting tools  
Drilling tools & Boring tools  
Turning & Milling Accessories  
Roughing Milling Cutter  
Fine boring system  
Wrench stellar & Wrench Hexagon



**TIMTOS**  
TWTC Hall 1F A0121

WEI GUAN CUTTING TOOLS CO., LTD.  
緯冠刀具有限公司  
No. 463 Tafeng Rd., Tali District, Taichung City, Taiwan

886-4-24929135 info@wei-guan.com.tw  
886-4-24929256 www.wei-guan.com.tw



產品報導

7 軸放電加工機



主軸不採用後拉式配重塊，搭配1KW伺服馬達及雙邊六塊滑塊結構設計，使主軸在做斜度加工時，定位精度(不偏擺)及提升滾珠導螺桿使用壽命。

- 六軸程式控制，XYZ+ABC(可替換為XYZ+ABW或XYZ+ACW)。
- W軸機頭傾斜，可做±60°傾斜加工。

- 工業級電腦(IPC)，在任何加工狀況，都能表現最穩定狀態。

- 本系統是採用windows CE 控制器；採以對話式視窗來呈現且搭配3D立體動態圖示描述功能；15吋彩色液晶觸控螢幕讓您輕鬆快速的動作；具有專門維修畫面來加快維修速度。

- 本機三軸均採用數字尺回授之全閉環迴路設計，故能使定位精度及ORBIT-CUT加工精度及效率大幅提升；採光學尺Close-Loop位置控制，精

度高；對話式程式，提供各種擴孔模式；自動編輯。可依材質、面積、加工深度、單側間隙、最終電流、電極磨耗等設定。

- CNC機型，同樣具有傳統式等能量釋放功能，加工穩定快速，電極消耗小，表面精度均勻；監視畫面加工路徑顯示和圖形顯示功能；主軸不採用後拉式配重塊，搭配1KW伺服馬達及雙邊六塊滑塊結構設計，使主軸在做斜度加工時，定位精度(不偏擺)及提升滾珠導螺桿使用壽命。

**迅捷整合科技有限公司**

電話：+886-4-2493-7866

傳真：+886-4-2493-3055

郵箱：paul@promptcnc.com

網址：www.promptcnc.com

攤位號碼：南港2館 P0806

**遠程監控馬達**

功能：利用私有雲的遠端監控系統，同步監測電流以控制設備及馬達轉距張力，監測電壓以控制速度。針對設備電流變化異常時，或遇到阻力提供資料做分析，判斷設備是否即將損壞。提供主動性告知，取代現有的驅動器或者變頻器利用產品損壞報警機制所提供的被動性資訊。

特色：利用wifi遠距離控制，不受



制線材的距離或電流干擾。

遠端監控及遠端控制。

工業私有雲的應用，防止公司的設備被駭客入侵不法。無感應器，時時監控即時資訊，且不需要安裝感應器。透過wifi減少大量配線的人工及費用。

**裕誠工業有限公司**

電話：+886-2-2679-3289

傳真：+886-2-2269-1460

郵箱：judy@homerunmotor.com

攤位號碼：G0261

**兩件式- (φ62 型) 客製原點定位夾持模組 (Φ170\*30-Pitch100-油壓式)**

功能：

1. 適用於 4.5 軸 CNC 銑床加工機。
2. 輔助 CNC 銑床加工，治具、模具快速定位。
3. 輔助 CNC 銑床加工，工件快速定位。大幅縮減 90% 工件交換時間。
4. 輔助 CNC 銑床加工，快速校機，無須重複校正座標系。大幅提升 90% 校機時間。

特色：

1. 兩件式夾持力 ≈ 2000KG。重複精度 ≤ 0.005mm。
2. 獨家專利設計-浮動機構裝置。自動補償定位拉栓(配合件)使用之耗損。
3. 自動補償定位拉栓(配合件)使用之耗損。
4. 定位拉栓(配合件)單一規格，無須分辨原點、徑向等。
5. 增加原點及副原點辨識環以及防呆定位 Pin 孔，防止治具放置方向錯誤。
6. 依照客戶機台孔位，英貴爾設有客製化服務。

使用機械手臂並透過英貴爾原點定位夾持系統，即可達到自動更換治具、模具進而走向無人化產線，達到工業 4.0 效能。而非早期機械手只能用於更換工件無法更換治具。

**英貴爾科技有限公司**

電話：+886-6-2430-253

傳真：+886-6-2421-869

郵箱：sales00@inngrit.com

攤位號碼：G0605

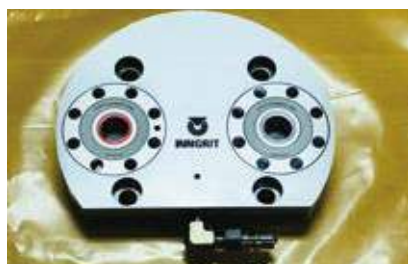

**軸件生產線上高精密智能量測系統**

功能：

1. TIMI遠心影像量測儀適用於汽車螺絲、軸心、沖棒及三角牙等軸桿件的高精密量測，可整合資訊科技的軟硬體設備，即時監控生產線上的自動量測。
2. 可提供品保部門進行速效的首件檢查及巡檢，以及生產部門進行生產線上自動量測。
3. 可整合機械手臂及資訊科技的軟硬體設備，以在量測儀與工具機之間自動取放加工物件，完成生產線上的自動量測。



特色：即時監控軸桿件量測全尺寸的最佳利器

1. 量測視野範圍大，而且量測精度達微米級。
2. 360°全周旋轉量測，直立工件可免夾持。
3. 操作介面人性化，即框即量，輕鬆上手。
4. 量測腳本可編輯，一個按鍵自動量測全尺寸。
5. 免手寫輸入，資料百分百正確。
6. 網路e化巡檢，可每分鐘自動檢查。

7. 生產資訊同步追蹤管理，省時，省工，防廢料。
8. 可客製化量測資料格式，相容於現有ERP系統。
9. 具量測大數據的製程統計分析，現場單機可立現X和R管制圖。

**優適達科技股份有限公司**

電話：+886-4-2359-8363 #530

傳真：+886-4-2359-8365

郵箱：marianne@usdvision.com

攤位號碼：G0204

**捨棄式中心鑽60度**

型號：TU、TU1系列

功能：1. 靜點幾近零偏心的設計，中心很準，鑽嘴不易斷裂，鑄鋼材質刀片、特殊幾何角度，可增加效率和壽命，減少重複換刀、校刀的時間。

2. 幾近零偏心設計，公差值 ±0.008mm，鑽嘴不易斷裂。

特色：1. 幾近零偏心設計，公差值 ±0.008mm，尖點不易斷裂。

2. 特殊刀片材料C350能有效提升刀尖壽命。

3. 可製作頂針孔。

**益壯企業有限公司**

電話：+886-2-8521-3035

傳真：+886-2-8522-3039

郵箱：a003@cut-tools.com.tw

網址：www.cut-tools.com.tw

攤位號碼：A0424



**SHINZAWA**

精度的絕對值 性價比的最佳選擇

Integrity, Service, Quality and Prominence



▲ SV-50S/65S/76S  
立式綜合加工中心機  
Vertical Machining Center



▲ SV-50DT/65DT  
鑽銼攻牙中心機  
Drilling Tapping Center

▲ S56-MT  
動柱式立式綜合加工中心機APC  
Traveling Column Vertical Machining Center



▲ VB-116/127/147/168/208  
立式綜合加工中心機(硬軌)  
Vertical Machining Center (Box way)



▲ SDC-8/10/12  
SDC-16/22/32  
龍門高速加工中心機  
CNC Double Column Machining Center



SV-85S/110S/130S  
SV-865S/1165S/1365S  
立式綜合加工中心機  
Vertical Machining Center

**2019 TIMTOS**  
Taipei Int'l Machine Tool Show  
Nangang Hall 2 P1002

震澤精密機械股份有限公司  
Shinzawa Precision Machinery Co., Ltd.

42854 台中市大雅區雅潭路三段537-1號  
TEL: +886-4-25690150 FAX: +886-4-25690165  
E-mail: info-cnc@shinzawa.com.tw



www.shinzawa.com.tw





# HYDRAULIC PRESS MAKER

**ODM & OEM**  
**In-House Design and Manufacture**

SPC DEES Hydraulic, a hydraulic press manufacturer with factories in Taiwan and China since 1976, is focusing on increasing our manufacturing flexibility, constructing global distribution networks, improving quality standards and reducing manufacturing costs for clients. DEES supplies customers such as Boeing, Honda, Toyota, Audi, Volkswagon, Mercedes-Benz, Volvo, Bosch Group home appliances, Electrolux, GE home appliances, Haier, Foxconn, and more. From 10 to 6,000 ton, DEES provides more than 4,500 custom-made hydraulic presses in the world.



**Dees Hydraulic Industrial Co., Ltd.**

TEL: +886-2-2601-8661 FAX: +886-2-2601-8936

E-mail: sales@spc.com.tw

www.deesgroup.com.tw



**TIMTOS** 2019  
 Mar.4-9  
 27<sup>th</sup> Taipei Int'l Machine Tool Show  
**Booth No. D0401**



# Quick Die Change System

Customized Designs Available 提供客製化設計

## Features

### For Mechanical Press

- Reduced in Die Change Time.
- Reduced Stock Inventory.
- Diverse Products in Small Batches.
- Improved Productivity and Quality.
- Reduced Labor Cost.
- Improved Operation Safety.
- Shortened Delivery Time.
- Better Working Environment.

## 特點

### 沖床專用快速換模系統

- 減少換模時間
- 多種少量的生產
- 減少存貨
- 降低勞力成本
- 增加操作安全
- 達成快速產銷
- 產量與品質改革
- 改善工廠環境



**TX-Type Die Clamp Series**  
TX型系列夾模器



**TY-Type Die Clamp Series**  
TY型系列夾模器



**Power Unit**  
氣動泵組合



**Die Arm Series**  
移模臂

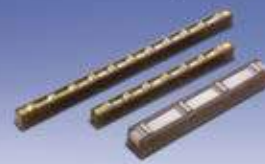

**Die Lifter Series**  
舉模器

**TIMTOS**

**2019**

**Booth No.:**

March 4-9

**D0530**

Taipei World Trade Center Exhibition Hall 1

**AGENT WANTED**

**富偉精機股份有限公司**  
FORWELL PRECISION MACHINERY CO., LTD.

T +886-4-834-5196 F +886-4-834-5197  
E forwell@forwell.com Skype: forwell

**富偉精密機械(寧波)有限公司**  
FORWELL PRECISION MACHINERY (NINGBO) CO., LTD.

T +86-574-8659-9196 F +86-574-8659-9197  
E forwell@forwellnb.com Skype: forwellnb

**富偉機械科技(淮安)有限公司**  
FORWELL MACHINERY TECH (HUAIAN) CO., LTD.

T +86-517-8565-9196 F +86-517-8565-9197  
E forwell@forwellha.com Skype: forwell.ha



Taiwan



Video Online



閱人文書店

書店·建構出城市的美好風景。台北有24小時不打烊的書店·為夜貓子留一處安靜的閱讀角落；台大公館商圈的獨立書店、二手書店以及古冊典籍字畫等特色書店·展現出台北人的文化涵養；中山地下書街跨越文化與世代·網羅上萬本書籍·還有影音主題專區·是全台最長的書街·結合一旁的咖啡、紅豆餅等美食小舖·讓閱讀變得更享受。



喝個性咖啡

咖啡館·是旅人認識台北的絕佳方式。大稻埕街區的老屋在精心改造下飄出咖啡香·遊走中山北路二段、赤峰街、永康街、青田街、富錦街.....·總能發現美好角落。台北的咖啡風情萬種·可感受世界各國不同的咖啡文化、欣賞特色設計風格·走進咖啡店·猶如置身異國風情；也有將咖啡館形塑一處親子空間、閱讀角落或創意設計基地·複合式的經營模式·讓喝咖啡有了更多想像。



親水岸遊河

淡水河與基隆河溫柔地環抱這座城市·台北人的生活更與河岸旁的親水公園密不可分·不僅是晨跑、夜騎、休閒的好去處·到了夏季·各式親水活動在此輪番上場·吸引三五好友相約聆聽音樂會·大手牽小手來此戲水消暑·還有機會在基隆河上划船·前往大稻埕碼頭·則可乘坐渡輪遊淡水河·以不同的視角欣賞城市美景與河岸風光。



看自然暖湯

台北市因四面群山環抱·加上交通發達·從繁華市區到郊山十分便利。從士林搭乘巴士就可到達的陽明山國家公園·是擁抱大自然的最佳去處；緊鄰信義商圈的四獸山步道不僅適合健行·更是觀賞跨年煙火·眺望台北美景的好地點；另外·內湖區的大湖公園·白石湖吊橋·大溝溪親水步道·更像是城市裡的一片綠洲·讓身心都澈底放鬆。



悠遊卡 (EasyCard) 、  
一卡通 (iPASS)

可於各捷運站及超商等地購買·加值後即可使用·每趟行程依票價扣款·還可當成電子錢包·在超商及特約商店小額付費·租還 YouBike 時亦可使用。



北北基好玩卡 (Taipei Fun Pass)

系列票卡包括「12處景點門票+交通」的「無限暢遊卡」、交通專用的「交通暢遊卡」、以及結合「故宮、台北101門票+可儲值悠遊卡」的「經典景點卡」3種票卡。旅客可在效期內暢遊台北市、新北市和基隆市·並可利用官網及App選購系列票卡及旅遊產品·省錢又便利。

Website



App



文字資料提供者：台北市政府觀光傳播局

只要一個步驟即可瞭解TIMTOS展覽訊息

今年您除了由榮格工業傳媒承辦的展會快報瞭解TIMTOS展會訊息之外·還可以通過**現場直播**·通過動態影片的即時報導·您可以無時無刻瞭解展會現況。

直播內容包含開幕典禮、採購洽談會、記者會、2019高峰論壇、學生參觀及導覽、工業4.0智慧製造研討會、智慧製造聯網數據增值產業聯盟會員大會、2019年台北國際工具機展歡迎酒會暨工具機研究發展創新產品競賽頒獎典禮、2019台北國際工具機展GLORIA智慧製造創新應用論壇以及展商採訪等等精彩內容。不論您是否在現場·都可以通過直播間·快速瞭解2019年TIMTOS的最新動態。

我們也誠摯邀請您前來榮格攤位獲取其他更多產業訊息·如金屬加工、汽車、醫療、智慧製造等。  
攤位號：南港1館I2138·歡迎前來交流。



掃描QR CODE立即看直播  
▲短影片更適合零碎時間觀看·提升觀看意願



Smart Management

Smart Machines

Smart Automation

與您攜手實踐工業4.0  
Realizing Your Smart Factory Dream



永進機械工業股份有限公司  
YEONG CHIN MACHINERY INDUSTRIES CO., LTD.  
TEL: 886-4-2562-3211 FAX: 886-42562-6479  
www.YCMCNC.com  sales@YCMCNC.com



27<sup>th</sup> Taipei International Machine Tool Show

Booth No. **J0618**  
March 4-9, 南港展覽館1館  
Nangang Exhibition Hall 1